

## Mobile-based monitoring system for an automatic cat feeder using Raspberry Pi

Nenny Anggraini<sup>1</sup>, Dzul Fadli Rahman<sup>2</sup>, Luh Kesuma Wardhani<sup>3</sup>, Nashrul Hakiem<sup>4</sup>

<sup>1,3,4</sup>Department of Informatics, Universitas Islam Negeri Syarif Hidayatullah Jakarta, Indonesia

<sup>2</sup>Institute of Computer Science and Technology, Peter the Great St. Petersburg Polytechnic University Russia, Russia

### Article Info

#### Article history:

Received Aug 15, 2019

Revised Jan 6, 2020

Accepted Feb 16, 2020

#### Keywords:

Internet

Mobile

Motor stepper

Pet monitoring system

Raspberry Pi

### ABSTRACT

In a Saheeh hadith it is explained that the cat is a clean animal that is free from najis, so keeping a cat is not something that is forbidden. One of the things that is important when keeping a cat is feeding. However, keeping a cat at home takes time and effort. In this digital era, the use of technology has penetrated all aspects of life. The objective of this research is to create a monitoring system for an automatic cat feeder using a webcam and a stepper motor that is connected to a Raspberry Pi as the main controller. The webcam can take pictures (photographs or videos) processed with the fswebcam and the avconv functions on the Raspberry Pi. The stepper motor can rotate the feed valve by utilising a General-Purpose Input Output (GPIO) pin and a program which is inserted into the Raspberry Pi. Next, the Raspberry Pi will be connected to the Internet and a server network so that the system control can be done remotely by using a web browser or web view on a mobile. The overall function of the system in the form of feeding the cat either directly or scheduled, as well as monitoring of photographs or videos around the feed. The results of a questionnaire showed that this system has a need value of 87.3% of 79 respondent cat keepers, meaning cat keepers will be greatly helped by the existence of this system.

*This is an open access article under the [CC BY-SA](https://creativecommons.org/licenses/by-sa/4.0/) license.*



### Corresponding Author:

Nenny Anggraini,

Department of Informatics,

Universitas Islam Negeri Syarif Hidayatullah Jakarta, Indonesia.

Email: nenny.anggraini@uinjkt.ac.id

## 1. INTRODUCTION

Raising animals is one of the long-standing human behaviours, according to Estep and Hetts [1], human-animal interactions can be defined as the degree of relatedness or distance between animal and humans. The relationship requires mutual individual recognition. Animals may respond to tactile, visual, olfactory, gustatory and auditory stimuli from humans. The quality of human-animal interactions will determine whether the influence on an animal's physiology and behaviour is desirable or otherwise [2].

Cats are one of the most popular pets in the world, including Indonesia. Historically, this animal has been part of human life since about 6000 to 10000 years ago [3]. About 4000 years ago in ancient Egypt, there was a relationship between humans and cats. The cat was even considered a sacred animal by the people of Egypt at that time [4, 5]. In Islam, cats have extraordinary features. This is known in one of the hadith from Abu Qotadah, that Rasullullah shallallahu 'alaihi wa sallam said:

إِنَّهَا لَيْسَتْ بِنَجِسٍ إِنَّهَا مِنْ الطَّوَّافِينَ عَلَيْكُمْ وَالطَّوَّافَاتِ

“This cat is not najis. Actually, cats are animals that we often meet and are around us.” (HR. At Tirmidzi, Abu Daud, An Nasa’i, Ibnu Majah, Ad Darimi, Ahmad, Malik, Syaikh Al Albani in Irwa’ul Gholil Number 173 said that this hadith is Saheeh) [6]. The hadith explains that the cat is a clean animal that is free from najis, so keeping a cat is not something that is prohibited but in fact is highly permissible, provided the cat is kept such that it loves its own family.

One of the things that is important when keeping a cat is feeding. However, keeping a cat at home takes time and effort. The data from the distributed questionnaires showed 66.2 % of the 77 respondents had sometimes not fed their pet cats largely due to forgetfulness and busyness. Under other conditions, 76 % of the 79 respondents who have homecoming activities just leave the cat, either entrusted or abandoned at home with the value of concern to meet the needs of the cat 63.1 % above 5 (1 to 10 scale) of 65 respondents. To solve the problem, the data obtained from other questionnaires, indicated that 87.3 % of 79 respondents need a tool that can help cat keepers.

Many studies related to the creation of a system or tool that can be a solution to make it easier for animal keepers to take care of their pets. In the research by Kim [7], two mini-computers were used in one work system that consumed a lot of electrical power, in addition to the control that was divided into two. Chung [8] devised a system with many different connected hardware, which could cause difficulties in the care and control of the system, especially for elderly users. Researchers Tessema [9], Prashant [10] and Manoj [11] used a simple microcontroller which made the system too static and difficult to develop functions. Based on the background of the problems, the formulation of several problems is:

- How to create a design of an automatic cat feed monitoring system?
- How do monitoring control systems (monitoring and givers) feed the cat?
- How to create a system that can be controlled by a mobile?

So, based on the analysis of the needs and problems that currently exist, there is a need to make improvements. As part of this process, a monitoring system can be built with remote control for the device using a mobile entitled “Mobile-Based Monitoring System for an Automatic Cat Feeder using Raspberry Pi”. To stay focused and in accordance with the stated objectives, the limitations are:

- The use of a Raspberry Pi as the main intelligence in the system.
- Issues to ease the provision of automatic cat feeder.
- Use the Prototyping method for system development.
- Communication between the system and the tools on mobile using WiFi (Internet).
- Cannot be applied for a cat with special needs.

## **2. RESEARCH METHOD**

### **2.1. Method of data collection**

Observation, Interview, Questionnaire and Study Literature are some of the methods of data collection. From some of these methods, It gained knowledge about how to make an automatic cat feeding system better than previous systems or similar products.

### **2.2. Systems development methods**

In the development of this system, the prototyping method has been used [12, 13]. The five stages of prototyping used in the system development process [14] follow the prototyping paradigm is shown in Figure 1.

#### **2.2.1. Communication phase**

During this phase, communication is achieved by searching related information through reference books and journals concerning the habit of cats when feeding. This is then discussed with experts and authors in the field of research.

#### **2.2.2. Requirements gathering phase**

In this phase, the collection of needs takes place in which data collection is performed by observation, interviews, and questionnaires with related parties and a literature study [15, 16]. This demand-gathering stage will continue to run as long as the prototype building continues until the testing phase of the tool.

#### **2.2.3. System build phase**

The building phase of this system is focused on making flowcharts, and then the flowcharts are divided more specifically into functions that can be used in the system [17]. In general, this starts with the Raspberry Pi controlling the camera and the stepper motor which can be accessed using a mobile connected via the Internet network. This is in order to further regulate the Raspberry Pi in terms of monitoring and

controlling the feeding schedule. At this stage, a block diagram of the system is also created with an explanation of each stage.

#### 2.2.4. System coding phase

In this phase, the program code is created for the Raspberry Pi 3 Model B using the Python programming language. In addition, programming is also done by using a server that is a database which is created to store data temporarily and control the GPIO through the Internet network. Internet access can be easily achieved because it uses Raspberry Pi 3 [18-20]. The next phase of making the interface involves using the web with the PHP language. Then the web is drawn using a web view to be accessed easily on a mobile, especially a smartphone. The application can manage and control the monitoring system [21-22].

#### 2.2.5. Test system phase

This phase uses black-box testing that aims to determine the functionality of the system or tool, testing each module and the integration of the overall unit program to determine whether the modules work in accordance with their duties [23-25]. The next step of using the tool is the stage of proof or implementation directly in the home with the users (cat keepers), in order to determine the achievement of the main purpose of making the system.

### 2.3. Proposed system

Based on the method of data collection, it can be seen that most systems that run today still use human labour directly in feeding the cat. This system really depends on the availability of human labour directly around the cat, because if human labour is not available for various reasons, then feeding the cat cannot be performed by the monitoring system. Figure 2 is the flow schemes for running the system analysis.

Based on the results of running the system analysis it would appear that several schemes use various aspects of the proposed system analysis in the form of an automated cat feed monitoring system using a mobile. Figure 3 is an overview of how the proposed system runs and performs as an Automatic Cat Feed Monitoring System using a Raspberry Pi 3 Model B and other supporting hardware (Logitech C310 HD Webcam and REES52 ULN2003 5V Stepper Motor + ULN2003 Driver).

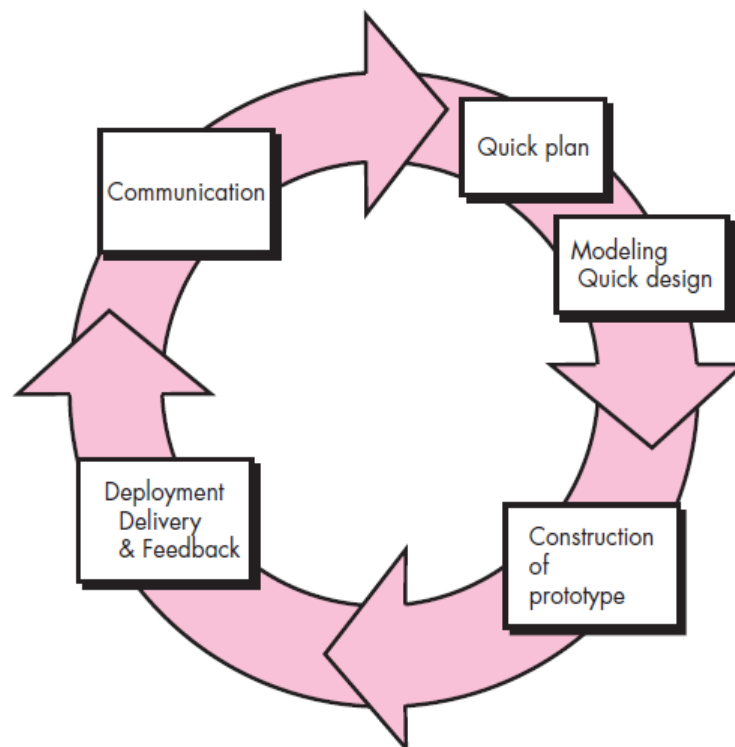

Figure 1. Prototyping paradigm

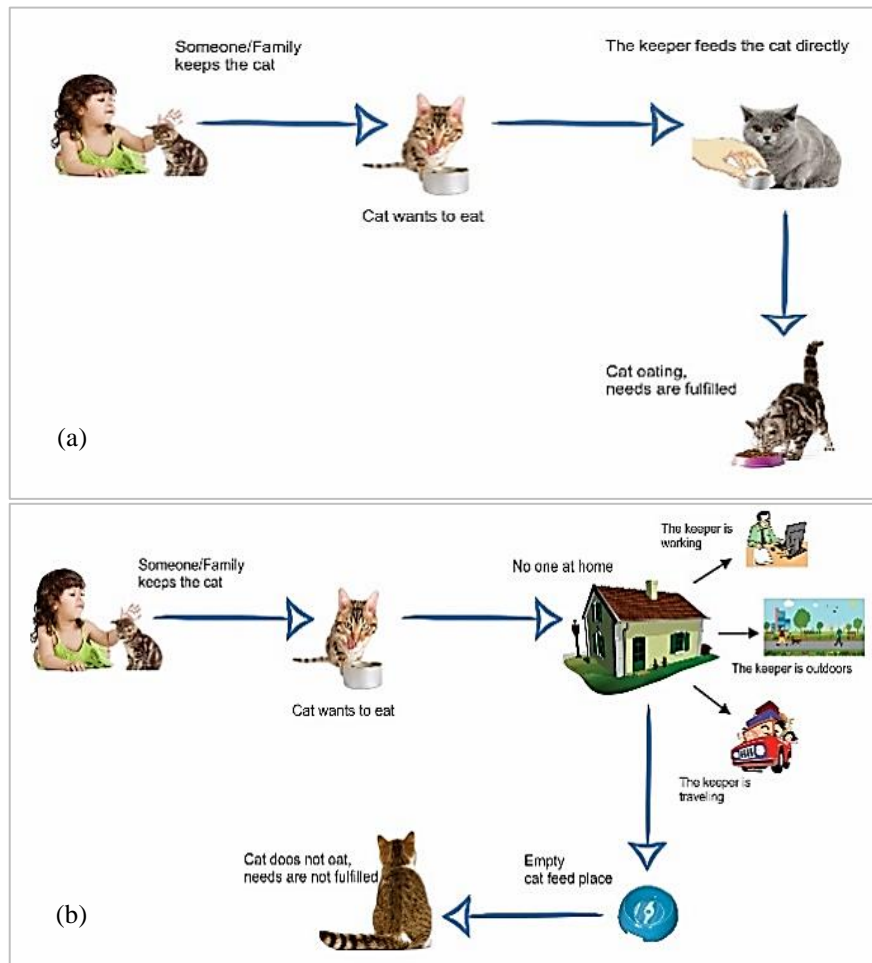

Figure 2. Analysis of the current system: (a) scheme 1, (b) scheme 2

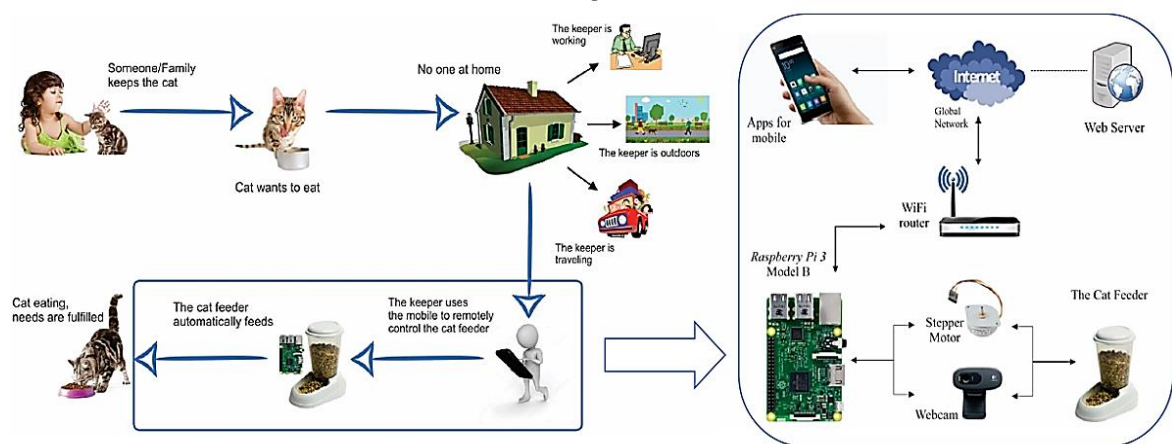

Figure 3. Proposed automatic cat feed monitoring system

### 3. RESULT AND DISCUSSIONS

#### 3.1. System work process

##### 3.1.1. Process on webcam

Web Camera will capture images if the command is run, then data from images will be sent to Raspberry Pi via USB port. The captured image from the webcam will be processed by Raspberry Pi into image

capture which is shown in Figure 4. This process is carried out with `fswebcam` and `libav-tools` which were previously installed in the Raspberry Pi. Figure 5 is the process carried out by Raspberry Pi with the `fswebcam` and `avconv` functions.

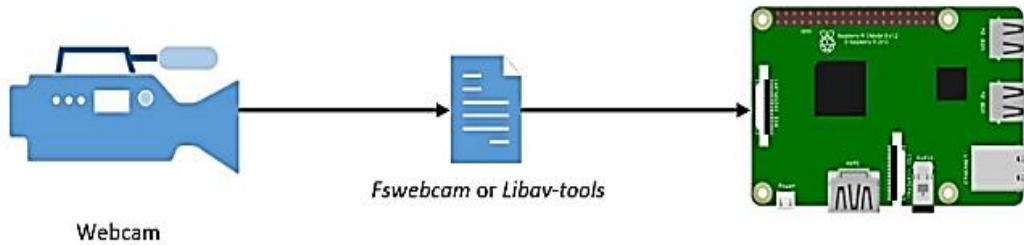

Figure 4. Capture images process

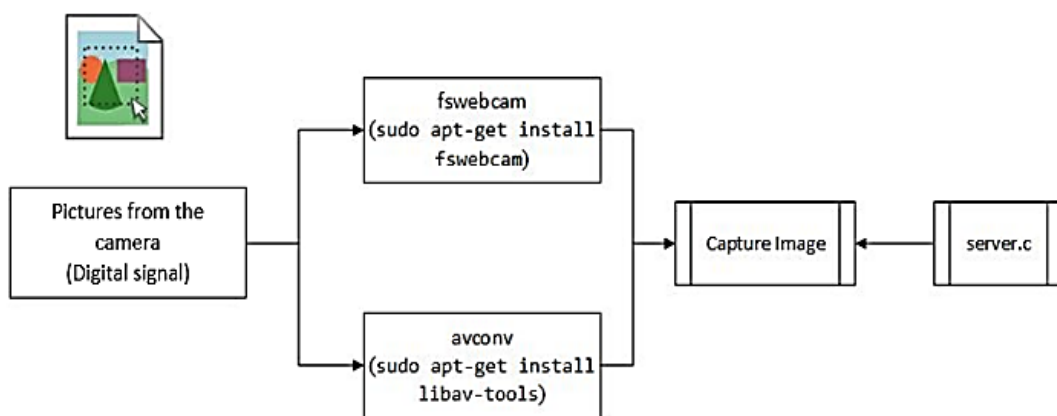

Figure 5. Motion process in Raspberry Pi

The process that takes place is the captured image, in this case the `fswebcam` or `avconv` function is run with code on `server.c`.

- `avconv` code found on `server.c` functions to capture video, with initialization:  
`"/usr/bin/avconv -t 5 -y -f video4linux2 -i /dev/video0 movie.ogg"`
- `fswebcam` code found on `server.c` functions to capture photos, with initialization:  
`"sudo /usr/bin/fswebcam -r 1280x720 test.jpg"`

To connect the Monitoring System Controller with a mobile web-based application, a web server is needed. Figure 6 shows the webservice functions as a liaison between the mobile and Raspberry Pi in the internet network, which Raspberry Pi will send data to the mobile web application, on the other side the mobile web also can send status to Raspberry Pi to take pictures in the form of photos or videos with a webcam that has been connected to Raspberry Pi. Here is a more specific process flowchart of each process running on `fswebcam` and `avconv`, as shown in Figure 7:

- Web Camera will capture images that have analog signals. When captured, images with analog signals are processed by the webcam so that it becomes a digital signal and then sent to the Raspberry Pi via a USB port.
- In the Raspberry Pi, the image is sent to the processor and then processed with `fswebcam` and `avconv` which have been preinstalled and stored on the micro sd. After being processed by the two tools above, the image will be displayed again in the form of a digital signal, in this process also involves RAM which is a temporary storage area. The captured images by the webcam will be processed and sent to the server by FTP (File Transferred Protocol), which then images or videos can be accessed via the mobile web by displaying on the available screen.

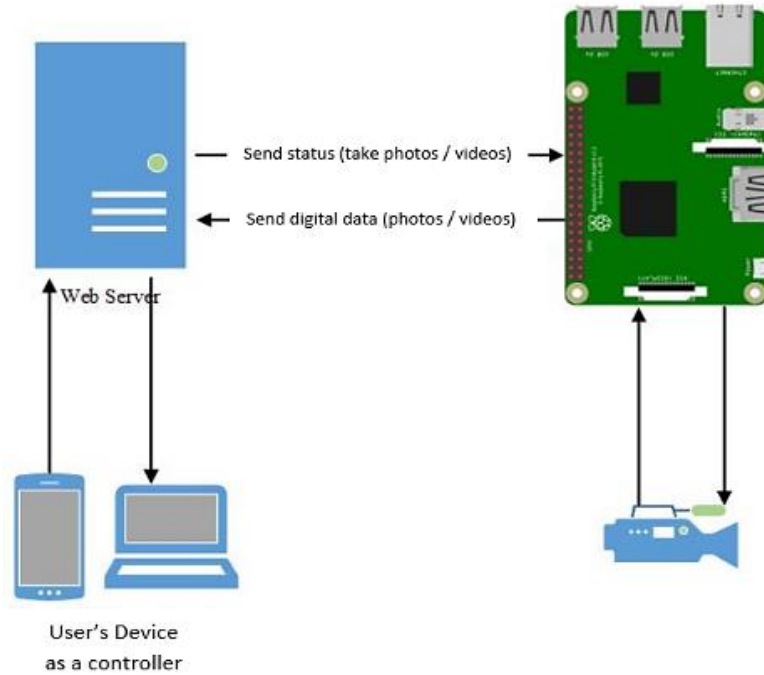

Figure 6. How the system is connected (1)

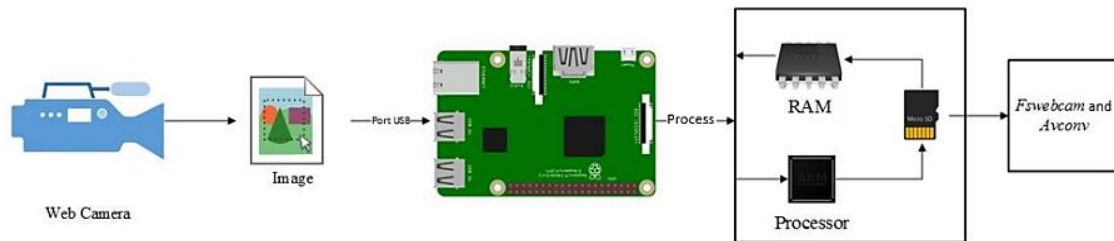

Figure 7. Process on raspberry Pi with fswebcam and avconv

**3.1.2. Process on stepper motor**

Stepper motor will move the feed valve if the command is run, then the feed will come out of the feed through the open valve. The stepper motor movement is an order that is processed by the Raspberry Pi with a program that has been implanted in the Raspberry Pi which is shown in Figure 8. This process is affected by the program that is in the `steperok1.py` code that has been saved in Raspberry Pi.

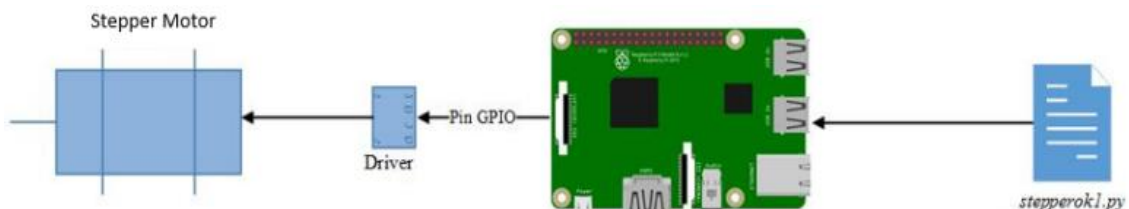

Figure 8. Stepper motor movement process

Figure 9 shows the webservice functions as a liaison between the mobile and Raspberry Pi in the internet network, as well as program storage. The following programs are available on the server (`schedule.php` & `server.c`) and Raspberry Pi (`steperok1.py`) to run the Stepper Motor:

- The main code in `schedule.php` to move the motor according to the specified scheduling, initials as follows:

```
date_default_timezone_set("Asia/Jakarta");
$getminute=date("H:i");
```

---

```
($getminute=='07:00' || $getminute=='12:00' || $getminute=='18:00')
```

- The code to move the motor contained on `server.c` with the initialization as follows:  
"sudo /usr/bin/python stepperok1.py -1000 0"
- The code to set the GPIO pin on the Raspberry Pi, and then connect it to the stepper motor driver, while the program initialization is as follows:

```
GPIO.setmode(GPIO.BCM)      GPIO.setup(5,GPIO.OUT)    GPIO.setup(12,GPIO.OUT)
GPIO.setwarnings(False)    GPIO.setup(6,GPIO.OUT)   GPIO.setup(13,GPIO.OUT)
```

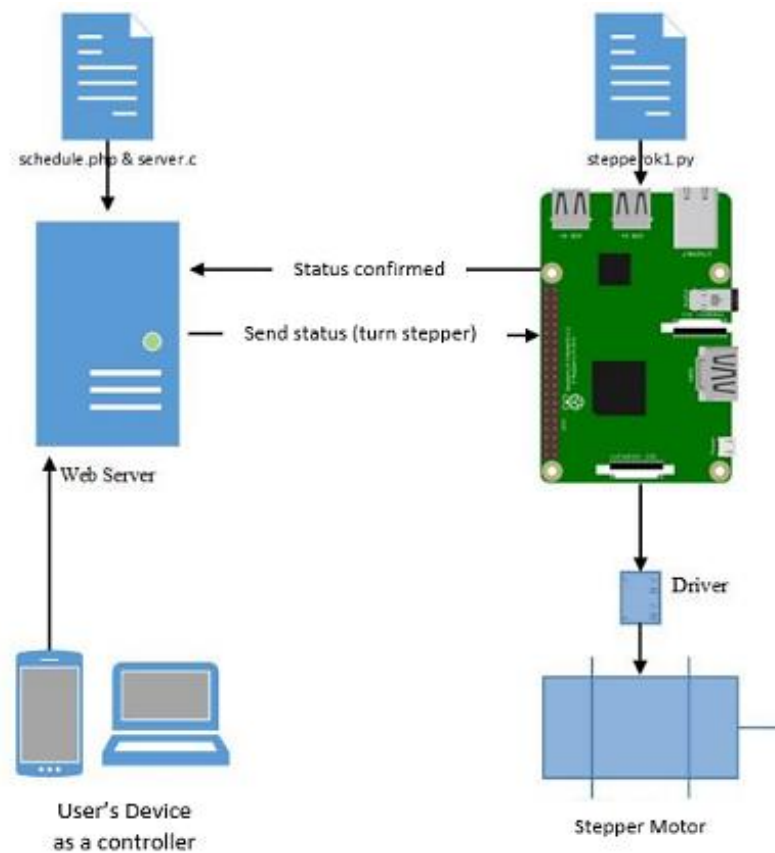

Figure 9. How the system is connected

Here is a more specific process flowchart of each process running on a stepper motor, as shown in Figure 10:

- Stepper Motor will move according to the current entering from the driver. The output current from the Raspberry Pi (microcontroller) cannot move the stepper motor. Then the driver is needed to supply the stepper motor current. Here the ULN2003 IC chip is used as a stepper motor driver.
- In the Raspberry Pi program to move the stepper motor is embedded, such as setting the GPIO pin which will be used as an output on the Raspberry Pi as well as the Ground or Volt connected to the driver, the selection of the GPIO pin is adjusted according to its function. In the process, the Raspberry Pi will issue a pulse signal which then the pulse signal will be captured and processed by the driver into a current that can move the stepper motor.

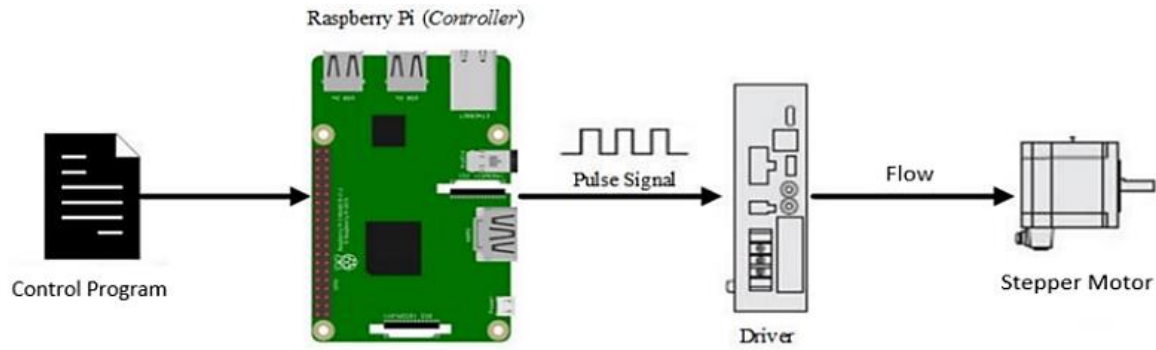

Figure 10. Process on Raspberry Pi to rotate the stepper motor

### 3.2. System testing

The functionality aspect uses the black box testing. Here are the results of the aspects of testing: aspects of functionality (black box testing). The tests focus on system functionality, especially the results of the input and output performed by the user. Table 1 shows the result of testing using the black box testing method. The whole system process works well as long as the Internet connection is also good. This is because the system work process requires stability of connectivity. As for taking pictures in the form of photographs or videos, this is shown in Table 2. Image or video capture can work on many different types of network, but there is a difference when reloading or refreshing the display of photographs or videos between web controls and devices across different networks.

Table 1. Image capture access on system

#	Module	Precondition	Expected results	Results
1	Connect online with the Internet	Internet connection	Effective and efficient	OK
2	Controlling distance with the tool is unlimited and limited only by Internet connection	Internet connection	The system can be easily accessed	OK
3	Displays updated information	Internet connection	Latest photos or videos	OK
4	Accessible via mobile	An Internet connection and mobile control	The display is attractive and easy to use	OK
5	Webcam can capture images in the form of photos or video	The webcam installed on Raspberry Pi and connected to the server	Display photos or videos	OK
6	The motor can rotate the feed valve	The motor is mounted on the Raspberry Pi and the server is connected	Cat feed can come out	OK
7	All command buttons can work according to the settings	An Internet connection and Raspberry Pi can access server	Buttons work fine	OK

Table 2. Image capture access on system

#	Photo	Video	Information
In one network	Working, 10 seconds waiting time	Working, 15 seconds waiting time	Once refreshed on the web
Different networks	Working, 10 seconds waiting time	Working, 15 seconds waiting time	2 to 4 times refreshed on the web

## 4. CONCLUSION

Based on the discussion that has been described above, it can be concluded that the cat feed monitoring system may work properly as is the objectives. The system consists of several items of hardware such as a webcam and a stepper motor that are connected to a Raspberry Pi as the main controller. Furthermore, the Raspberry Pi is connected to the Internet network, so it can be controlled remotely via the mobile web. Feeding (direct or scheduled) and monitoring is done by accessing the server by the mobile web for subsequent forwarding and running of the feed by the Raspberry Pi. The monitoring system uses fswebcam and avconv functions installed on the Raspberry Pi to take pictures in the form of photographs or videos via a webcam. A stepper motor serves as a feed valve driver with a program that has been entered into the Raspberry Pi, which also has settings for the GPIO pins. Each function can be controlled with the buttons



shown on the mobile web connected to the Internet network. The cat feed monitoring system can be accessed via the mobile web with a web browser or a web view application on a smartphone by connecting to the server on the Raspberry Pi online through the Internet network.

After the development of this Mobile-Based Auto Feed Monitoring System, there are several suggestions that can be made for the next reader and developer. In the subsequent development to complete the cat feed monitoring system, the hardware used can be more varied such as using a Sensor or Voice Record. Further development of the monitoring system is advised to feed the cat by using a higher resolution camera so that the image obtained can be better quality and clearer. In addition, also to use a larger stepper motor so that the revolutions can be stronger and faster when feeding the cat. It is advisable to create a mobile app that can work on a wider range of platforms, such as on Android, iOS, Windows Phone and on other mobile operating systems. Lastly, research into the requirements of cats themselves can be undertaken, such as feeding cats that have special needs.

## REFERENCES

- [1] D. Q. Estep, and S. Hetts, "The Inevitable Bond-Examining Scientist-Animal Interactions.," Davis H, Balfour AD, editor. Cambridge: CAB International, Interactions, relationships and bonds: the conceptual basis for scientist-animal relations, pp. 6–26, 1992.
- [2] P. H. Hemsworth, and H. W. Gonyou, "Animal Welfare.," Appleby MC, Hughes BO, editor. Wallingford: CAB International, Human contact, pp. 205–218, 1997.
- [3] J. A. Serpell, "Domestication and history of the cat," The Domestic Cat: The Biology of its Behaviour (3<sup>rd</sup> edition), eds D.C. Turner and P. Bateson. Cambridge University Press, no. 7, pp. 84-87, 2014.
- [4] Larson G., Fuller D. Q, "The Evolution of Animal Domestication," *Annu. Rev. Ecol. Evol. Syst.*, vol. 66, pp. 36–115, 2014.
- [5] R. Alves, "Relationships Between Fauna and People and the Role of Ethnozoology in Animal Conservation," *Ethnobiology and Conservation*, vol. 1, no. 2, pp. 1-69, 2012.
- [6] Muhammad Nasiruddin al-Albani, "Irwa' Al Ghalil," *Najla Press*, 2003.
- [7] S. Kim, "Smart Pet Care System Using Internet of Things," *Int. J. Smart Home*, vol. 10, no. 3, pp. 211-218, 2016.
- [8] C.-M. Own, H.-Y. Shin, and C.-Y. Teng, "The Study and Application of the IoT in Pet Systems," *Adv. Internet Things*, vol. 3, pp. 1–8, 2013.
- [9] T. Gelila Berhan, W. T. Ahemed, and T. Z. Birhan, "Programmable Pet Feeder," *Int. J. Sci. Eng. Res.*, vol. 3, no. 11, pp. 99–104, 2014.
- [10] P. Singh, A. K. Sharma, P. Sood, and P. Singh, "Remote Controlled and GSM Based Automated Pet Feeder," *Int. J. Electr. Electron. Eng. IJEEE*, vol. 2, no. 2, 2015.
- [11] M. Manoj, "Automatic Pet Feeder," *Int. J. Adv. Sci. Eng. Technol.*, vol. 3, no. 3, pp. 9–11, 2015.
- [12] M. Alavi, "An Assessment of the Prototyping Approach to Information Systems Development," *Magazine Communications of the ACM*, vol. 27, no. 6, pp. 556-563, 1984.
- [13] J. D. Naumann and A. M. Jenkins, "Prototyping: The New Paradigm for Systems Development," *MIS Quarterly*, vol. 6, no. 3, pp. 29-44, 1982.
- [14] R. Pressman and B. Maxim, "Software Engineering: A Practitioner's Approach," 8<sup>th</sup> ed. McGraw-Hill, 2014.
- [15] A. Bryman, "Integrating Quantitative and Qualitative Research: how is it done?," *Sage Journals*, vol. 6, no. 1, pp. 97-113, 2006.
- [16] J. H. Frey, A. Fontana, "The Group Interview in Social Research," *The Social Science Journal*, vol. 28, no. 2, pp. 175-187, 1991.
- [17] G. S. Krohn, "Flowcharts Used for Procedural Instructions," *Research Article*, vol. 25 no. 5, pp. 573-581, 1983.
- [18] W. Gay, "Raspberry Pi Hardware Reference," *New York: Apress*, 2014.
- [19] M. Maksimović, et al., "Raspberry Pi as Internet of Things hardware: Performances and Constraints," *Proc. of 1<sup>st</sup> Int. Conf. on Electrical, Electronic and Computing Engineering*, vol. 6, pp. 1-6, 2014.
- [20] H. K. Merchant and D. D. Ahire, "Industrial Automation using IoT with Raspberry Pi," *International Journal of Computer Applications (0975 – 8887)*, vol. 168, no. 1, pp. 44-48, 2017.
- [21] S. Walia, and S. K. Gill, "A Framework for Web Based Student Record Management System using PHP," *International Journal of Computer Science and Mobile Computing*, vol. 3, no. 8, pp. 24-33, 2014.
- [22] C. Supaartagorn, "PHP Framework for Database Management based on MVC Pattern," *International Journal of Computer Science & Information Technology (IJCSIT)*, vol. 3, no. 2, 2011.
- [23] P. Black and D. Wiliam, "Inside the Black Box: Raising Standards Through Classroom Assessment," *King's College, London*, pp. 1-13, 1998.
- [24] S. Nidhra and J. Dondeti, "Black Box and white Box Testing Techniques - a Literature Review," *International Journal of Embedded Systems and Applications (IJESA)*, vol. 2, no. 2, 2012.
- [25] M. E. Khan and F. Khan, "A Comparative Study of White Box, Black Box and Grey Box Testing Techniques," *International Journal of Advanced Computer Science and Applications*, vol. 3, no. 6, 2012.