

An optimum dynamic priority-based call admission control scheme for universal mobile telecommunications system

Anike Uchenna, Ajibo Chinenye Augustine, Chinaeke-Ogbuka Ifeanyi Maryrose,
Odo Chinedu Matthew, Amoke Amobi Douglas, Ani Cosmas
Department of Electronic Engineering, University of Nigeria, Nigeria

Article Info

Article history:

Received Aug 14, 2019

Revised Jan 6, 2020

Accepted Feb 4, 2020

Keywords:

3G

CAC

IoTs

QoS

UMTS

ABSTRACT

The dynamism associated with quality of service (QoS) requirement for traffic emanating from smarter end users devices founded on the internet of things (IoTs) drive, places a huge demand on modern telecommunication infrastructure. Most telecom networks, currently utilize robust call admission control (CAC) policies to ameliorate this challenge. However, the need for smarter CAC has becomes imperative owing to the sensitivity of traffic currently being supported. In this work, we developed a prioritized CAC algorithm for third Generation (3G) wireless cellular network. Based on the dynamic priority CAC (DP-CAC) model, we proposed an optimal dynamic priority CAC (ODP-CAC) scheme for Universal Mobile Telecommunication System (UMTS). We then carried out simulation under heavy traffic load while also exploiting renegotiation among different call traffic classes. Also, we introduced queuing techniques to enhance the new calls success probability while still maintaining a good handoff failure across the network. Results show that ODP-CAC provides an improved performance with regards to the probability of call drop for new calls, network load utilization and grade of service with average percentage value of 15.7%, 5.4% and 0.35% respectively.

This is an open access article under the [CC BY-SA](#) license.



Corresponding Author:

Ajibo Chinenye Augustine,
Department of Electronic Engineering,
University of Nigeria, Nsukka, Nigeria.
Email: augustine.ajibo@unn.edu.ng

1. INTRODUCTION

The third generation (3G) wireless networks also called “Universal Mobile Telecommunication System” has amongst other features, a call admission control (CAC) mechanism that is adjudged to have the capacity to consider different service classes and also take the advantage of the changing nature of multimedia service. This is in a bid to minimize the probability of call drops while also ensuring that end users enjoy improved QoS [1-3]. With the recent increase in the interest in data inspired communication and multimedia services, attributable to the rise in smarter end user devices and the quest for interaction amongst things; heralded by the IoTs, the development of multiple-class CAC schemes for modern communication infrastructure has become even more challenging [4]. Critical issues bordering on fairness, service prioritization, and resource allocation policy have taken central stage in deliberations geared towards improving CAC schemes for future generations of wireless cellular networks [5].

CAC schemes play a dual role to both the network and end users as they provide users with access network services while at the same time serving as the decision-making part of the network for optimal

network resource utilization [6, 7]. Several CAC schemes have been proposed in literatures. However, the complete sharing (CS) based scheme, such as hybrid priority CAC (HP-CAC) and queuing priority CAC (QP-CAC), have been established to produce the best resource utilization [8-10]. Though with the deficiency of not guaranteeing the independent QoS demand for a certain group of service.

In this work, we present an optimum dynamic priority call admission control (ODP-CAC) that takes into account the aforementioned challenges associated with DP-CAC scheme. The proposed scheme, adopts a dynamic approach in that the diversified network traffic load of modern telecom network requires admission control policies to be adaptive to the varying traffic pattern. The ODP-CAC, using renegotiation, explored the unused bandwidth of the network and allocate such to services which at the point of admission into the network were availed insufficient resources. This bandwidth renegotiation is done for a lower priority services in the event of the availability of the medium. Thus, improving the overall bandwidth usage of the lower priority classes.

To realize the specific intent of this work, the remaining part of this work is ordered as follow: Section 2 provides a survey of related studies centering on CAC. Section 3 presents an analytical description of the adopted DP-CAC model. Furthermore, an in-depth insight of the proposed ODP-CAC algorithm was explored. Subsequently, in section 4 we carried-out the simulation of the developed DP-CAC and ODP-CAC models, and also investigate their performance by subjecting them to voice, video, and real-time services. Then simulation results were analyzed and discussed. Finally, Section 5 concludes and makes recommendations for future work.

2. OVERVIEW OF RELATED WORKS

Several methods have been proposed recently in literatures for radio resource distribution in mobile networks. We thus, present a review of some of these studies. [11, 12], proposed a priority-based resource distribution scheme for voice and data services in a homogeneous network using the limited fractional guard channel (LFGCP). Their study, took into consideration handoffs owing to user adaptability, varying traffic properties, and changing service load. Numerical results from their proposed scheme, revealed its ability to concurrently provide sufficient QoS for both services while also maintaining a reasonable network resource utilization. Similarly, Khanjari et.al, [13] proposed a QoS sensitive and guaranteed adaptive CAC for multiclass service in mobile network. The proposed model utilizes bandwidth leasing and prediction techniques in prioritizing traffic classes for a maximum allocation of the available bandwidth. This technique was found to improve bandwidth utilization. It was also found to reduce the blocking probability of calls significantly. Also, [14] proposed a CAC technique that utilizes the interference estimation and differentiation of QoS demand for separate services. The interferences in this case, is estimated from the impact of the to-be-admitted new call on the QoS of the existing connections in the adjacent cells. Higher chances of admission were given to calls adjacent to their serving base station (BS) and those experiencing lower path-loss. While calls emanating from the edge of the serving cell and having large path-loss to the serving BS had the tendency of introducing excess interference to adjacent cells as such they were given lower admission probability. Results from simulation revealed that the proposed scheme performs better in outage and blocking probabilities. However, the issue of call hand-off was not considered in the scheme. In [15, 16], an optimal joint call admission control (JCAC) for inter-radio access technology (RAT) was developed to cater for issues associated with cell re-selection for the support of real-time and non-real-time services. The proposed JCAC utilizes a cost function that compares the blocking and accepting costs respectively. The scheme also utilizes a semi-markov decision process (SMDP) in formulating its optimization problem. Finding from their study revealed that the proposed optimal JCAC was able to select bigger RAT for real-time service while smaller RAT was allocated to non-real-time services.

Furthermore, [17] proposed a radio resource management (RRM) scheme which integrated resource-reservation estimation (RRE) and CAC; their study was founded on the concept of interference guard margin (IGM) for CDMA systems. The CAC scheme offered higher priority to handoff calls by reserving a specific amount of resource based on the IGM. The RRE which was implemented in each BS assisted the RRM in dynamically adjusting the level of IGM. Wang and Zhuang [18], on the other hand proposed a CAC for a code division multiple access (CDMA) network that supports heterogeneous self-similar data traffic. Their techniques, guaranteed service requirements for both calls and packet in the network. The GoS for their schemes with respect to the supported service were evaluated in terms of handoff call dropping probability and packet transmission delay respectively. Results from simulation revealed that the proposed scheme was able to satisfy both QoS and GoS requirements for supported traffic and was also able to realize efficient network resource utilization. In [19, 20] a real-time dynamic CAC scheme that jointly provide connection-level QoS and packet-level QoS for heterogeneous and varying multimedia traffic in the next generation wireless networks was proposed. The proposed scheme was found

to be computationally-efficient for real-time implementation. Preliminary simulation showed that scheme realized better performance relative to the stationary CAC scheme under heterogeneous and varying multimedia traffic load conditions. In addition, [21] proposed a CAC that protects users with strict transmission bit-rate requirements, while also offering sufficient capacity to delay-tolerant services over prolonged duration. [22] proposed a complete sharing (CS)-based dual threshold bandwidth reservation (DTBR) algorithm which handles two broad classes of traffic voice traffic (high priority) and data traffic (low priority) was proposed. The total system bandwidth C was divided into three partitions by using two fixed thresholds T_1 and T_2 ($T_2 < T_1$). When the total occupied bandwidth was less than T_2 , both voice and data traffic were serviced by the system. While in cases where the occupied bandwidth was more than T_2 but less than T_1 , only voice calls were serviced and when the occupied bandwidth was more than T_1 , no service was provided. [23] proposed a bandwidth reservation CAC scheme, where priority was given to unsolicited grant service (UGS) connection by allocating a predetermined value of the total network bandwidth. The fixed bandwidth served to guarantee guaranteed QoS for UGS. Moreover, a degradation model was also developed by the authors to reduce non-real time packet switch (nrtPS) connection from its peak sustained traffic rate in a bid to reduce traffic rate in order to allow for more UGS, real time (rtPS) and non-real time packet switch (nrtPS) non-degradation mode. In contrast, only UGS and nrtPS connections were addressed in their proposed algorithm.

In summary, most of the reviewed literatures tried to address issues centering on GoS indicators: call blocking and dropping probability, by favoring the handoff calls over new call in their CAC policies; with the justification that supporting an ongoing call is more important than accepting a fresh one. To the best of our knowledge, none of these studies attempted the rerouting of the un-transmitted packets which we envisage could help maximize the overall network resource utilization. We thus seek to develop an optimal dynamic priority CAC scheme which seek to cater for the aforementioned gap while also guaranteeing QoS of each service class.

3. SYSTEM DESCRIPTION

For this study, two types of services: real-time service (RT), such as conversational and streaming traffic, and non-real-time service (NRT) such as interactive and background services were considered. To realize the objective of this study, we divide the priority classes of incoming call requests into four groups namely: (group1) RT service handoff requests; (group2) NRT service handoff requests; (group3) newly originating RT calls; and (group4) newly originating NRT calls as shown in Table 1.

The capacity of a typical WCDMA cell in terms of its cell load is described thus: the load factor, η , is the instantaneous resource utilization upper bounded by the maximum cell capacity η_{max} . Instantaneous values for the cell load range from 0 to 1. Using this load factor, we developed a QoS-aware CAC algorithm for WCDMA-based networks using the concept of thresholds and queuing techniques as shown in Figure 1. Each call category has its unique queue represented as Q1, Q2, Q3 and Q4 each with fixed sizes: K , L , M and N respectively. In this scheme, call class request is assigned its queue on arrival when such request on arrival cannot be serviced owing to resource unavailability. Such request is later assigned a resource when available based on its calculated priority.

Let η_i , be the load margin (LM) of the i^{th} ($i = 1, 2, 3$ and 4) traffic group, while η_{max} represents the maximum loading that can be tolerated by the network. Based on the set loading threshold, we realized two CAC schemes namely: the hybrid priority CAC (HP-CAC) scheme which has set LM for each group and the dynamic priority CAC (DP-CAC) scheme which utilizes the fixed load partition and the set system load to adaptively admit the queued calls. The priority of traffic classes is dynamically adjusted in a bid to ensure that the higher priority class maintains higher priority in as much as the lower priority class do not suffer any consequence by this act. One of the setbacks with the HP-CAC scheme is that unused marked out loading limits for higher priority groups cannot be utilized by lower class traffic thus resulting in a waste of network resource. Also, there is an overwhelming of traffic of lower priority as more preference is given to traffic of higher priority at all point in time. The DP-CAC scheme ameliorates the aforementioned setbacks with HP-CAC by providing tolerable QoS for each traffic class and preventing higher traffic class from suppressing lower traffic class in order to enhance fairness in resource allocation. We thus present an overview of the DP-CAC in section 3.1.

Table 1. Traffic class and description

Class	Traffic groups	Request types	Class descriptions
1	RT	Handoff calls	Conversational and streaming
2	NRT	Handoff calls	Interactive and background
3	RT	New calls	Conversational and streaming
4	NRT	New calls	Interactive and background

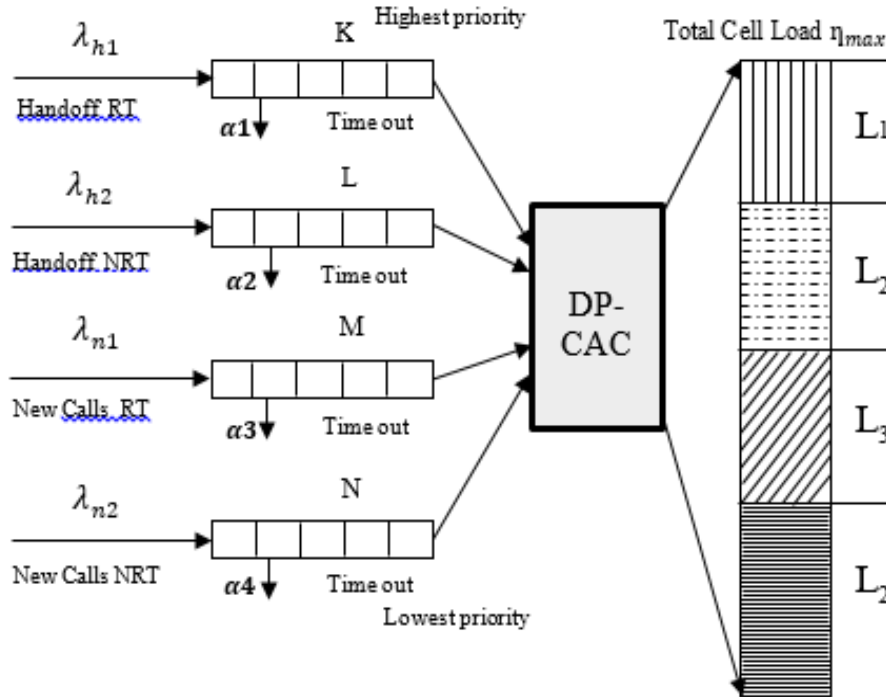

Figure 1. Dynamic priority call admission control (DP-CAC) scheme

3.1. Overview of the DP-CAC scheme

We present a step description of the DP-CAC procedure as thus:

- The arrived class *i* call is served as long as (1) is met.

$$\Delta\eta_i + \eta_c \leq \eta_{max} \tag{1}$$

- Fresh calls are assigned their respective queue when all resources are utilized.
- Called are removed from the queue when they exceed set queuing time.
- When trunks capacities are released, priority values are dynamically computed for all call classes with non-empty queues using the total load currently occupied by class *i* calls in (2) and the load partition predefined for class *i*th calls in (1):

$$O_i = (1 + f) \sum_{i=1}^{B_i} \frac{v_i}{1+G_i/\rho_i} \leq L_i \tag{2}$$

where, O_i is the total usage load occupied by each connected call class *i* at an instance, and L_i is the size of the load partition. B_i is the number of connected class *i* call at an instance. Then, the queue with least priority value is served first based on first-in-first-out (FIFO) policy. The dynamic priority value for class *i* call is determined by (3).

$$P_i = \frac{O_i}{L_i} \tag{3}$$

In this scheme, traffic class *i* with a minimum priority P_i value are assigned the highest priority. Also, as the total instantaneous load of class *i* calls drop below the pre-fixed partition size L_i , its priority value reduces. Hence, it will receive a high priority. In a situation where two or more call classes have the same priority value, then the call with lower class index (higher priority) will be served first. With this algorithm, unused load of one traffic class can be utilized by other traffic classes as the demand arises. Also, at high system load, the priority value will prevent the classes from enormously affecting each other. The flowchart of the DP-CAC algorithm is shown in Figure 2.

Though the DP-CAC remediate the failures of the HP-CAC, it however, fail to provide a satisfactory dropping probability for handoff calls. It however, fails to decrease the blocking probability of

a new call to desirable level. We thus propose an optimal dynamic priority call admission control (ODP-CAC) takes into account aforementioned issues associated DP-CAC scheme. Section 3.2 presents a description of the ODP-CAC scheme.

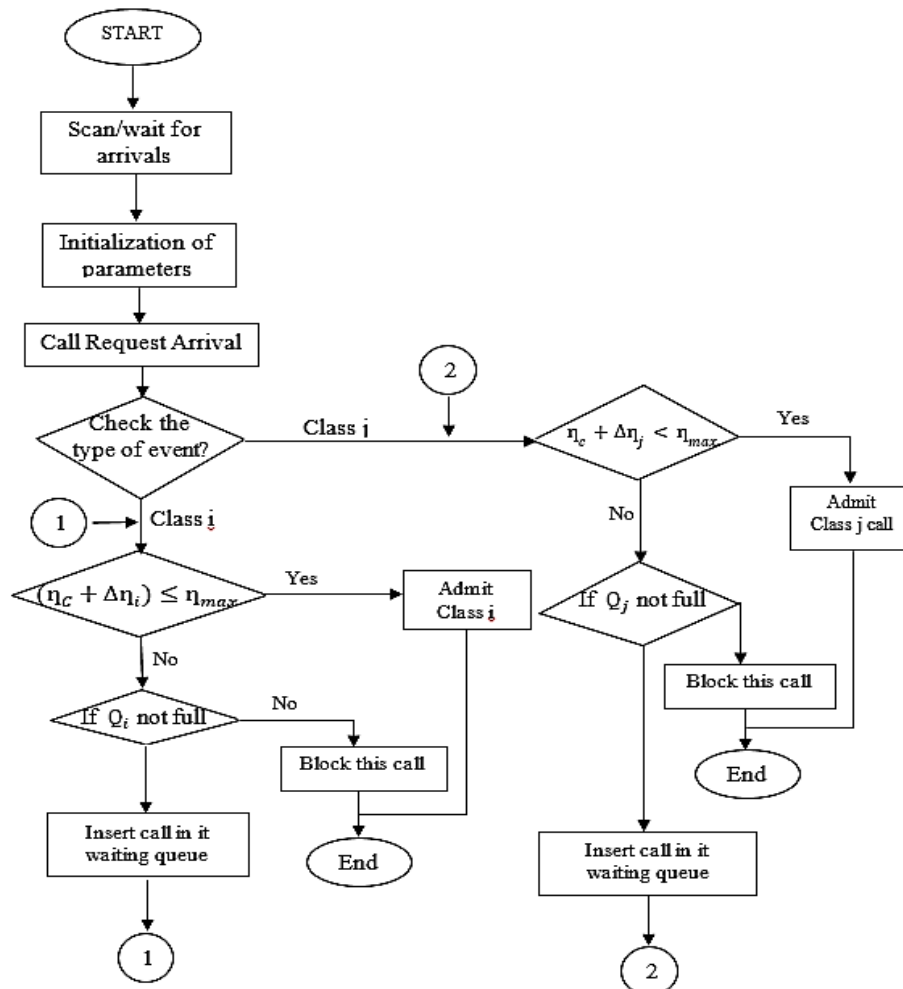

Figure 2. Dynamic priority call admission control (DP-CAC) Flowchart

3.2. Overview of the ODP-CAC schemes

For the proposed scheme, we adopted a dynamic approach for CAC. This is to accommodate for the diversity associated with the traffic pattern generated by smarter end user devices. The proposed ODP-CAC scheme uses renegotiation, in exploring the unused bandwidth of the network and in assigning resource to services which were under furnished with their required network resource at the point of admission into the network. This scheme differs from DP-CAC scheme in that it utilizes a queuing system to enhance the success probability for new calls and also for retransmitting unused bandwidth.

The algorithm utilizes the effective load as an admission requirement and applies varying thresholds for hand-off and new calls. If the total instantaneous usage load O_i occupied by each connected call class is less than 1, i.e., $O_i \leq 1$ where $i \in \{1, 2, \dots, k\}$, the class is said to be using less than its allotted fair share bandwidth. In this case, the maximum bandwidth b_{imax} , is assigned to the incoming calls either from the maximum loading η_{max} , or by degrading ongoing calls of class i ($i \neq j, i \in \{1, 2, \dots, k\}$) with higher O_i values than O_j i.e., $O_i > O_j$. If b_{imax} bandwidth not available, b_{imin} bandwidth is allotted following the same procedure as above. If neither b_{imax} nor b_{imin} bandwidth is available, the new call is rejected. The optimal DP-CAC scheme flowchart is shown in Figure 3.

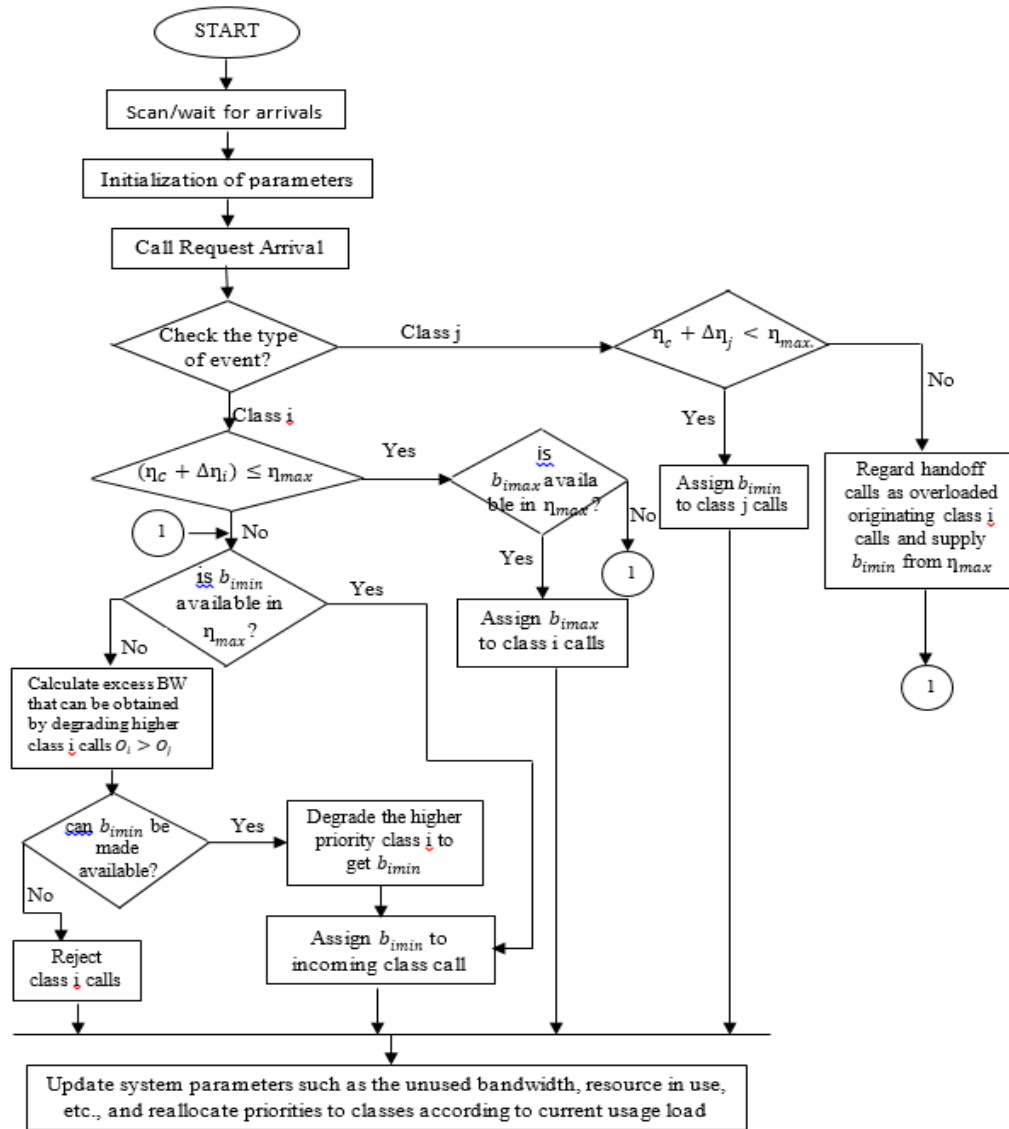

Figure 3. Optimal dynamic priority call admission control (ODP-CAC) flowchart

4. SIMULATION AND RESULT ANALYSIS

We adopted the traffic model established in [9, 25], for this study. Markov modulated poisson process (MMPP) was assumed for traffic arrival processes of new and handoff calls, belonging to each call class, with traffic arrival rates of $\lambda_{h1}, \lambda_{h2}, \lambda_{n1}, \lambda_{n2}$, for real time (RT) handoff, non-real time (NRT) handoff calls, real time (RT) new calls and non-real time (NRT) new calls, respectively. We computed the the total arrival rate of the system λ , using (4):

$$\lambda = \lambda_{h1} + \lambda_{h2} + \lambda_{n1} + \lambda_{n2} \tag{4}$$

Similarly, the channel holding time for the various call class are exponentially distributed with mean value given as μ^{-1} while the queuing time limit of each handoff calls class is exponentially distributed with mean γ_j^{-1} . Using the above definitions, the generated load of each traffic class i , denoted by ρ_i is given by:

$$\rho_i = \mu_i^{-1} \tag{5}$$

The total load offered to the system is given as ρ , and computed using (6):

$$\rho = \mu_i^{-1}(\lambda_{h1} + \lambda_{h2} + \lambda_{n1} + \lambda_{n2}) \quad (6)$$

the simulation parameters for the proposed schemes are presented in Table 2.

Table 2. Table of simulation parameters

Parameter	Value
Radio access mode	WCDMA (FDD) uplink with perfect power control
Chip rate	3.84 Mcps
Spread spectrum	5.0 MHz
WCDMA channel rate	2.0 Mbps
Slot duration	0.667 ms
Frame duration	10 ms
Dedicated channel rates	12.2, 64, 128, 256, 384 kbps
RT active factor (class 1 and 3)	0.4
NRT active factor (class 2 and 4)	1
Max. cell load	100% of pole capacity
Class 1, 2, 3, and 4 load margin	0.35, 0.25, 0.2 and 0.2
Packet arrival	Poisson
Packet generation type	Exponential
Queue type	FIFO, Priority
TTI	100

4.1. System performance measures

The following system performance metrics as described below was used in evaluating the performance of both algorithms.

- a. Call dropping probability: this is calculated using (7)

$$P_{hj} = \frac{\text{failedhandoffattempt}}{\text{totalnumberofhandoffattempted}} \quad (7)$$

- b. Call blocking probability: this is computed using (8)

$$P_{ni} = \frac{\text{failnewcallsattempt}}{\text{totalnumberofnewcallattempted}} \quad (8)$$

Grade of service (GoS): the GoS is defined as:

$$GoS_j = \alpha * P_{hj} + P_{ni} \quad (9)$$

where P_{hj} is the probability of handoff failure, and P_{ni} is the blocking probability for new traffic belonging to ($j = 1, 2$) RT and NRT respectively $\alpha = 10$ indicates penalty weight for dropping a handoff call relative to blocking a new call. It is pertinent to mention that it is always desirable to have smaller GoS value as it indicates improved performance.

- c. System utilization (U): this represent the mean number of connections in each traffic group that the system can accept for a given traffic intensity. It is defined as n_i . The bandwidth (b_i) of connection i is defined by the load increment, $\Delta\eta_i$, such that, $b_i = \Delta\eta_i$. The average system utilization is defined as:

$$U = \sum_{i=1}^4 (n_i) \cdot (b_i) = \frac{\hat{\eta}}{\eta_{max}} \quad (10)$$

where $\hat{\eta}$, is the average utilized load.

4.2. Simulation results

This section presents the simulation results of the proposed ODP-CAC scheme and that of the DP-CAC under the same conditions. At the end of each simulation we obtained an evaluation of call dropping probability P_{hj} and call blocking probability P_{ni} . We also obtain the mean resource utilization which is an important criterion for evaluating the performance of any typical CAC algorithms. It is pertinent to mention that it is always desirable to realize a network utilization of about 100%. In the simulation results, a percentage value is used to compare the performance of both schemes.

4.2.1. Handoff call dropping probability

In a typical network, the drop of a handoff traffic is similar to a dropping a fresh call from the perspective of the user. Thus, it is desired that the fraction of traffic that suffer this loss be significantly low. Figure 4 shows the handoff call dropping probability comparison of DP-CAC and ODP-CAC for different traffic intensity. It is seen that the dropping probability of handoff call is smaller than that of newly admitted calls. Similarly, Figure 5 shows that the traffic load of the network increases, as a result of the CAC operation. But no significant improvement was observed from both schemes.

4.2.2. New Traffic blocking probability

Figure 5 compares the performance of the new calls blocking probability of our proposed optimal DP-CAC scheme with that of DP-CAC scheme. As anticipated, this figure shows a linear relationship between traffic intensity and loss for bandwidth demanding services. Thus, resulting in an increase drop rate for new traffics. Our proposed scheme outperformed the DP-CAC by an average percentage value of 15.7% improvement. This is owing to the fact that the scheme offers less blocking to fresh traffic while satisfying the QoS and GoS demands of other services already admitted into the network. The ODP-CAC scheme is able to achieve this for newly originating calls, by allocating bandwidth to the lower priority class which got a lesser resource either from the unused bandwidth of the network or by degrading the overloaded higher priority call requests.

4.2.3. Grade of service

The GoS against traffic intensity for an aggregation of traffic demand is depicted in Figure 6. The improved performance of the ODP-CAC over the DP-CAC by an average percentage value of 5.4% comes from the use of queuing to enhance the new call success probability (i.e., one minus the blocking probability).

4.2.4. Utilization

Figure 7 shows the system utilization comparison of our proposed ODP-CAC scheme with that of DP-CAC scheme. It can be noted that, the utilization of ODP-CAC scheme outperform that offered by DP-CAC scheme as results shows an average utilization improvement of 0.35% percentage value. At high traffic intensity the ODP-CAC scheme was also able to achieve a cell capacity utilization of 98%. This is attributable to the fact that the ODP-CAC scheme was capable of rerouting the unused network resources by dynamically controlling priority level of queued traffic.

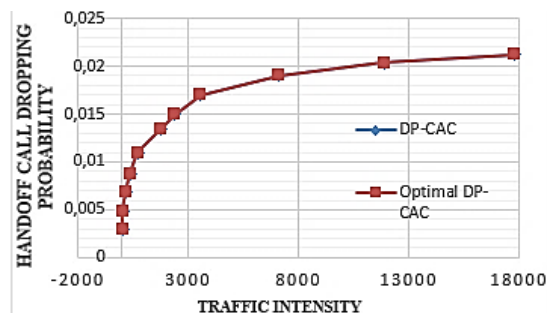

Figure 4. Handoff traffic dropping probability against traffic intensity

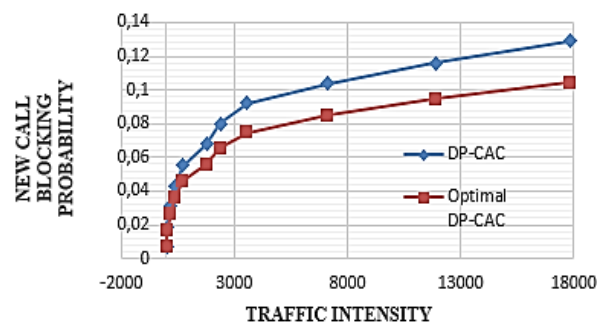

Figure 5. New traffic blocking probability against traffic intensity

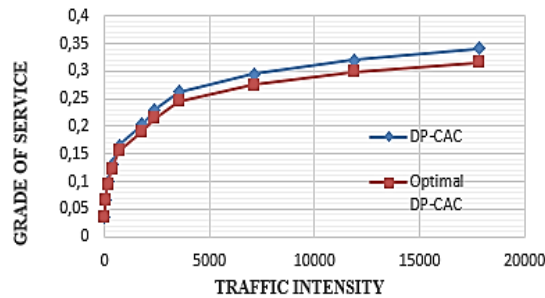

Figure 6. GoS against traffic intensity

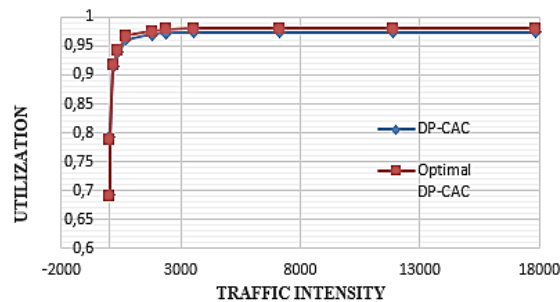

Figure 7. System utilization as a function of traffic intensity

5. CONCLUSION

In this study, an optimal dynamic priority call admission control (ODP-CAC) scheme was proposed. The scheme was extended to WCDMA by using adaptive loading range of η_1 , η_2 , η_3 and η_4 in order to assign priority to handoff RT request, handoff NRT request, new RT request and new NRT request respectively. Owing to the dynamism currently associated with end user devices attributable to the demand for connectivity for all things, we proposed an adaptive CAC policy to enhance the 3G system performance. The most significant advantage of the new proposed scheme is its dynamic behavior which allows for flexible adaptation to the continuously changing network parameters, which is the main shortcoming of the traditional bandwidth-based solution. Results obtained from simulation indicates that by degrading the handoff call request when not effectively utilize and by exploring and retransmitting the unused network resources, it is possible to decrease the loss rate for new traffic demand. Similarly, our findings reveal that in addition to better performance in QoS provisioning the ODP-CAC scheme also achieves a better network resources usage. Significant improvement has been realized by using queuing to enhance the lower priority class (i.e., new calls request) and by means of lowering the associated dropping probability of new traffic with the resultant improvement in the utilization of cell capacity. However, this comes at the detriment of other higher priority class. Further research is thus recommended in this area to improve fairness of the proposed ODP-CAC scheme.

REFERENCES

- [1] Yao J., Xiao L., Nie C., Wong D.T.C., and Chew Y.H. "Resource allocation for end-to-end QoS provisioning in a hybrid wireless WCDMA and wireline IP-based DiffServ network," *Eur. J. Oper. Res.* vol. 191, no. 3, pp. 1139–1160, 2008.
- [2] Patil G. U and Deshmukh C. N., "CAC Scheme for 3G Wireless Cellular Networks with QoS Provisioning and Queuing Traffic," *International Journal of Research in Computer Engineering and Electronics*, vol. 2, no. 1, pp. 1–5, 2013.
- [3] Ajibo A., Chinaeke-Ogbuka I., Udechukwu F., "Comparative analysis of LTE backbone transport techniques for efficient broadband penetration in a heterogeneous network morphology," *TELKOMNIKA Telecommun Comput El Control*, vol. 17, no. 5, pp. 2226–2234, 2019.
- [4] Abedin S., Alam G., Kazmi A., Tran N., Niyato D., Hong C., "Resource allocation for Ultra-Reliable and Enhanced Mobile Broadband IoT Applications in Fog Network," *IEEE Transactions on Communications*, vol. 67, no. 1, pp. 489–502, 2019.

- [5] Sallabi F., Shuaib K., and Shafique M., "Quality of Service provisioning for UMTS network users with immediate and advance radio resource reservations," *Journal of the Franklin Institute*, vol. 104, no. 6, pp. 468–479, 2006.
- [6] Kumar S., "A Comparative Study of Call Admission Control in Mobile Multimedia Networks using Soft Computing," *International Journal of Computer Applications*, vol. 107, no. 16, pp. 5–11, 2014.
- [7] Alhihi M., Khosravi M., Attar H., Samour M., "Determining the Optimum Number of Paths for Realization of Multi-path Routing in MPLS-TE Networks," *TELKOMNIKA Telecommun Comput El Control*, vol. 15, no. 4, pp. 1701-1709, 2017.
- [8] Alqahtani S. A., and Mahmoud A. S., "Performance analysis of two throughput-based call admission control schemes for 3G WCDMA wireless networks supporting multiservices," *Computer Communications*, vol. 31, no. 1, pp. 49–57, 2008.
- [9] Osuwagu H. O., Ajibo A. C., Ugwuanyi S. O., Nwachi-Ikpo J., and Ani C. I., "Dynamic bandwidth scheduling for WCDMA uplink transmission," *International Journal of Scientific & Engineering Research*, vol. 8, no. 2, pp. 798-805, 2017.
- [10] Setiyo B., and Arisetyanto N., "A New Model of Genetic Zone Routing Protocol (GZRP): The Process of Load Balancing and Offloading on the UMTS-IEEE 802.11g Hybrid Networks," *TELKOMNIKA Telecommun Comput El Control*, vol. 15, no. 2, pp. 598-605, 2017.
- [11] Leong C. W., Zhuang W., Member S., and Cheng Y., "Optimal Resource Allocation and Adaptive Call Admission Control for Voice/Data Integrated cellular networks," *IEEE Transactions on Vehicular Technology*, vol. 55, no. 2, pp. 654–669, 2006.
- [12] Chen W., Yu J., Pan F., "Optimal priority-based call admission control scheme for QoS provisioning in heterogeneous wireless networks," *Journal of Networks*, vol. 6, no. 2, pp. 319-329, 2011.
- [13] Khanjari S. A., Arafah B., Day K., and N. Alzeidi, "Bandwidth borrowing-based QoS approach for adaptive call admission control in multiclass traffic wireless cellular networks," *International Journal of Communication Systems*, vol. 26, no. 7, pp. 811-831, 2011.
- [14] Huang Q., Chen H. M., Ko K. T., Chan S., Chan K. S., "Call Admission Control for 3G CDMA Networks with Differentiated QoS," *International Conference on Research in Networking*, pp. 636–647, 2002.
- [15] Carvalho G. H. S., Woungang I., Anpalagan A., Coutinho R.W. L., and Costa J. C. W. A., "A semi-Markov decision process-based joint call admission control for inter-RAT cell re-selection in next generation wireless networks," *Comput. Networks*, vol. 57, no. 17, pp. 3545–3562, 2013.
- [16] Kaur S., Selvamuthu D., "Adaptive joint call admission control scheme in LTE-UMTS networks," In *2014 IEEE International Conference on Communication, Networks and Satellite (COMNETSAT)*, pp. 63-70, 2013.
- [17] Chen H., Kumar S., and Kuo C. C. J., "QoS-aware radio resource management scheme for CDMA cellular networks based on dynamic interference guard margin (IGM)," *Comput. Networks*, vol. 46, no. 6, pp. 867–879, 2004.
- [18] Wang L. and Zhuang W., "A Call Admission Control Scheme for Packet Data in CDMA Cellular Communications," *Wirel. Commun. IEEE Trans*, vol. 5, no. 2, pp. 406–416, 2006.
- [19] Huang L. and Kuo C. J., "Dynamic Call Admission Control with Joint Connection-level and Packet-level QoS Support in Wireless Multimedia Networks," *IEEE Symposium on Real-Time and Embedded Technologies and Applications*, May 2004.
- [20] Rejeb S. B., Nasser N., Tabbane S., "A novel resource allocation scheme for LTE network in the presence of mobility," *Journal of Network and Computer Applications*, vol. 46, pp. 352-61, 2014.
- [21] Lizhong L., Bin L., Bo L., and Xi-Ren C., "Performance Analysis of Bandwidth Allocations for Multi-services Mobile Wireless Cellular Networks," *Proc. IEEE Wirel. Commun. Netw. Conf.*, 2003.
- [22] W. L. and D. P. A. Haitang Wang, "Dynamic Admission Control and QoS for 802.16 Wireless MAN," *Symposium, 2005 Wireless Telecommunications*, 2005.
- [23] Wei D., Ansari N., "Implementing fair bandwidth allocation schemes in hose-modelled VPN," *IEE Proceedings-Communications*, vol. 151, no. 6, pp. 521-8, Dec. 2004.
- [24] Kokila S., Shankar R., Dananjayan P., "Performance analysis of dual threshold call admission control in 3G/WLAN coupled network," In *IEEE-International Conference on Advances in Engineering, Science and Management (ICAESM-2012)*, 2012.
- [25] Augustine A., Chukwudi I., Cosmas A., "Performance Evaluation of Enterprise-Wide Network that Its Backbone Is Based on Leased Trunk," *International Journal of Communications, Network and System Sciences*, vol. 8, no. 10, pp. 399-407, 2015.