

Design and manufacturing of iris waveguide filters for satellite communication

Hicham Setti¹, Asmae Mimouni², Abdelwahed Tribak³

¹Advanced Sciences and Technologies Laboratory, Polydisciplinary Faculty, University of Abdelmalek Essaidi, Larache, Morocco

²Department of Physics, College of Science, Allmam Mohammad Ibn Saud Islamic University (MSIU), Riyadh 11623, Saudi Arabia

³Microwave SMARTS Group, National Institute of Posts and Telecommunications (INPT), Rabat, Morocco

Article Info

Article history:

Received Oct 10, 2021

Revised Sep 25, 2022

Accepted Oct 26, 2022

Keywords:

Bandwidth

Filter

Insertion loss

Rectangular waveguide iris

ABSTRACT

We propose in this paper, two bandpass filters in waveguide technology having rectangular symmetrical discontinuities with a half-radius r , designed and operating respectively in the X-Band (9–11.5) GHz and C-Band (3.5–5.5) GHz. These filters consist of eight irises placed symmetrically respectively on standard rectangular waveguides WR90 and WR229 in which resonant irises are inserted. These irises are used to couple the sections very strongly in this filter, which allows the bandwidth to be increased and the matching to be controlled. The comparison between the numerical and electromagnetic results, which we obtained for the filters, constitutes a means of validation of computer simulation technology (CST) environment and Mician for the design of the other circuit elements in the various frequency bands. We observed excellent consistency between the simulation curves and those of the measurements. The results obtained are promising and pave the way for the use of these structures in the fields of telecommunications.

This is an open access article under the [CC BY-SA](https://creativecommons.org/licenses/by-sa/4.0/) license.



Corresponding Author:

Hicham Setti

Advanced Sciences and Technologies Laboratory, Polydisciplinary Faculty

University of Abdelmalek Essaidi, Larache, Morocco

Email: hsetti1981@gmail.com

1. INTRODUCTION

Filters in waveguide technology are widely used in satellite communication systems as well as in microwave telecommunications systems. Filtering is an electronic function whose role is to eliminate a frequency or a frequency band, or vice versa, to pass a frequency or a frequency band. Volume technologies are based on the use of rectangular or circular waveguides, dielectric resonators or metal cavities. These technologies are the most suitable for filtering high power signals [1]-[3]. Several types of filters have been reported in the literature: there are post type filters, stub type, inserted metal type, waveguide loaded by dielectrics, and waveguide loaded by ridge sections [4].

In the design of microwave or millimeter wave components, discontinuities play a particularly important role. These discontinuities are used to perform various types of functions: filtering, phase shifting, and power matching. In the case of our evanescent mode filters, the discontinuities are created by obstacles made up of symmetrical or asymmetrical rectangular irises. Many methods have been used to model the uniaxial discontinuities in cascade [5]-[7], the scattering matrix of the set will be obtained by carrying out the scattering of the individual discontinuities, assimilated to multi-poles and separated from each other by waveguide sections of lengths equal to the distances between the discontinuities.

As mentioned in the context of this study, there are various filtering solutions in terms of technology and topology. In this article, the electrical as well as technological specifications of the filters to be designed

in the high frequency bands are provided. These specifications often condition the choice of device technology. The choice of technology is one of the main problems in the design of devices operating in the microwave and microwave band. Its choice depends on many factors, such as bandwidth, physical circuit size, losses, power handling capability, and competitive manufacturing costs. This has led to many different transmission media for the implementation of circuits and systems [8]-[10].

We present the procedure for designing and producing iris filters. The modeling of the various discontinuities is analyzed by the modal matching method (MMM). The scattering of the whole structure will be obtained by chaining the generalized scattering (GSMs) of the individual discontinuities [11]-[17].

We propose in this paper, two band-pass filters in waveguide technology having rectangular symmetrical discontinuities, designed and tested respectively in the band (9–11.5) GHz and the band (3.5–5.5) GHz. These filters consists of 8 irises placed symmetrically respectively in a standard WR90 and WR 229 waveguide. These irises are used to very strongly couple the sections in this filter, which allows to increase the bandwidth and therefore controlling the filters matching.

2. DESIGN OF SYMMETRICAL IRIS FILTER

The inductive irises in the rectangular waveguide filters are illustrated in Figure 1, each one is formed by two transverse discontinuities separated by a waveguide section as illustrated in Figure 2.

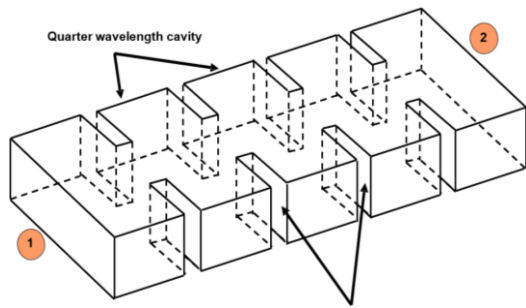

Figure 1. Electromagnetic model of a symmetrical iris filter formed by 8 sections

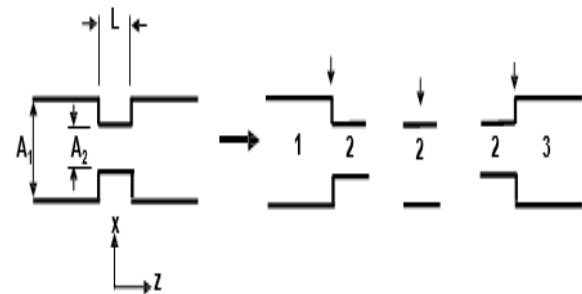

Figure 2. Inductive iris discontinuity

By means of the electromagnetic simulator, we obtain the scattering matrix *S* (Figure 3(a)) of the iris (Figure 3(b)) and we calculate thereafter its equivalent network in *T*. Each iris is represented by two series inductors *X_s* and a parallel inductor *X_p*, as illustrated in Figure 3(c).

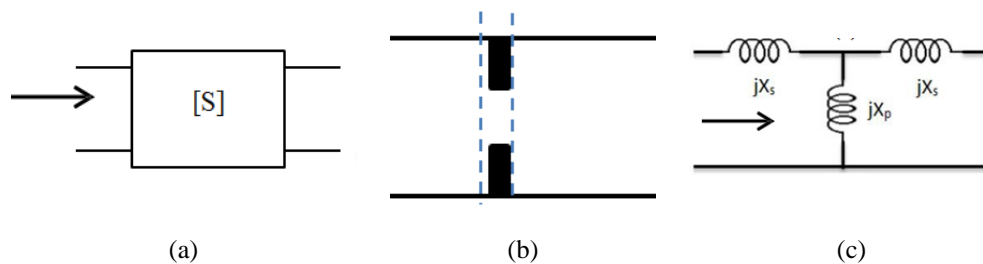

Figure 3. Waveguide filter: (a) iris, (b) matrix *S* equivalent, and (c) equivalent *T* diagram

The equations which relate the scattering matrix to the values of the inductors are described in [18] and (1), (2).

$$j \frac{X_s}{Z_0} = \frac{1 - S_{12} + S_{11}}{1 - S_{11} + S_{12}} \tag{1}$$

$$j \frac{X_p}{Z_0} = \frac{2S_{12}}{1 - S_{11}^2 - S_{12}^2} \tag{2}$$

Once the values of the inductors are obtained, we calculate its corresponding value of the impedance inverter through the following:

$$\phi = -\arctan\left(2\frac{X_p}{Z_0} + \frac{X_s}{Z_0}\right) - \arctan\frac{X_s}{Z_0} \tag{3}$$

$$\frac{K}{Z_0} = \left| \tan\left(\frac{\phi}{2} + \arctan\frac{X_s}{Z_0}\right) \right| \tag{4}$$

To design the iris using a determined value of the inverter K , we will vary the aperture of the iris, and using an electromagnetic simulator, we get its S parameters and then the values of X_s , X_p , K and ϕ . Thus, knowing the value of K we can identify the corresponding value of ai , and by means of the associated parameter ϕi we calculate the length of the resonator through the following:

$$l_r = \frac{\lambda_{g0}}{2\pi} \left[\pi + \frac{1}{2}\phi_r + \phi_{r+1} \right], r = 1, \dots; N \tag{5}$$

The following figure shows the different equivalent circuits of the filter with waveguide iris, as illustrated in Figure 4(a). To adapt the equivalent circuit of Figure 4(b) to the shape of the impedance inverter K . The Figure 4(c) present a section of length $\phi/2$ and $-\phi/2$ on each side of the discontinuity. This addition of lengths does not change the original circuit. This method gives the approximate dimensions of the filter, but optimization of the parameters is necessary to determine the appropriate dimensions that give an optimal response of the desired filter.

Traditionally, microwave analysis was based on approximate equivalent circuits of the device composed of concentrated elements (coils, capacitors) and distributed (transmission lines), which do not take into account all the electromagnetic interactions that occurred in the structure. Currently, there are rigorous techniques that take into account all the effects whose predictions coincide perfectly with the actual measurements of the devices. More detailed information can be found in references [19]-[25].

When the scattering parameters for each mode at each discontinuity are derived and are related for all modes in the expansion using the scattering parameters of the waveguide section separating the two discontinuities, the iris scattering parameters can be calculated. The configuration of an iris discontinuity is shown in Figure 5. When port 1 is excited by the TEn0 mode, the transverse components of the electromagnetic field scattered in the discontinuity contain only the ‘y’ component of the electric field and the x ‘component of the magnetic field. So, the electromagnetic fields in region 1 and 2 can be expressed as the superposition of the modal functions of the TEn0 modes in the waveguide and in each section. In order to facilitate the manufacturing process, a small curvature of radius r has been added, which will slightly modify the geometry of the start. Likewise, we studied the effect of these curvatures on the results of the parameters $|S_{ij}|$ and we have found that these curvatures do not strongly influence the filter results. The dimensions and geometry of this filter.

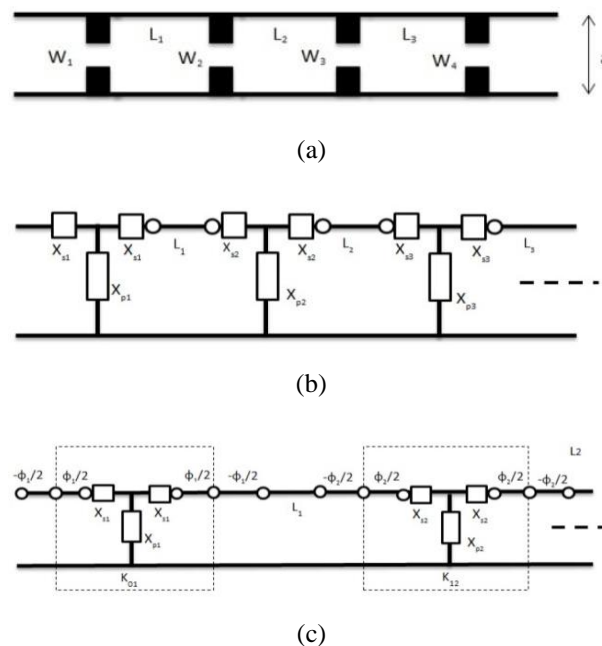

Figure 4. Third-order iris filter in the waveguide: (a) filter seen from above, (b) equivalent circuit, and (c) equivalent circuit modified

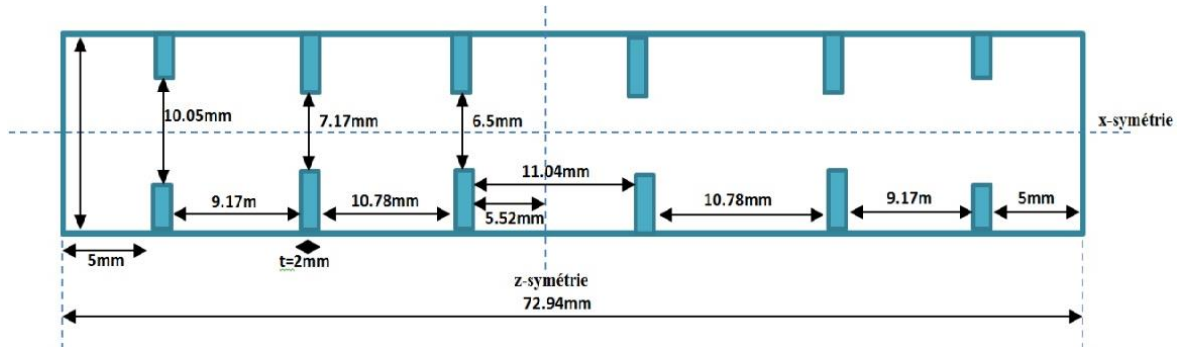

Figure 5. Structure of the volume filter in the X-Band

3. SIMULATION AND EXPERIMENTAL RESULTS

In order to measure this filter, we made the prototype using the milling technique on the hardware of Alumina-6850 and we tested it using a network analyzer type PNAE8364A from Agilent Technology, after thru-reflected-line (TRL) type calibrations. In the two prototypes we tested we used 8 iris discontinuities separated by quarter wavelength cavities. Figure 6 shows a mechanical prototype of one of the two symmetrical filters.



Figure 6. Prototype of a symmetrical filter formed by 8 symmetrical irises discontinuities

This section, it is explained the results of research and at the same time is given the comprehensive discussion. Results can be presented in figures, graphs, tables and others that make the reader understand easily. The discussion can be made in several sub-sections. We have taken into consideration the presence of rounded corners, because in practice the cavity corners cannot practically be rectangular in shape due to the radius of the milling tool. The comparison between the experimental and electromagnetic results, which we obtained for the filters, constitute a means of validation of CST environment and Mician for the design of the other circuit elements in the different frequency bands. The two filters that we have analyzed are symmetrical and consist respectively of standard rectangular waveguides WR90 and WR229 in which resonant irises are inserted. Figure 7 and Figure 8 show the comparison between the simulations and the experimental results.

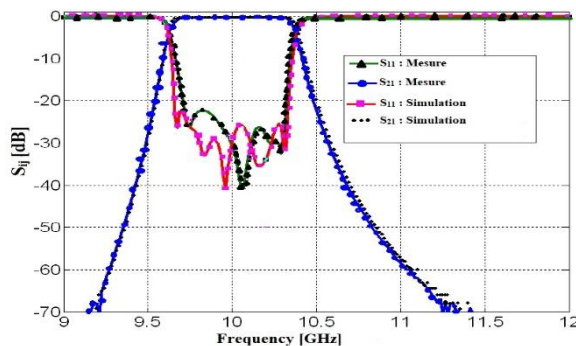

Figure 7. Comparison of theoretical reflection coefficients and those obtained by measurements, X band (WR90)

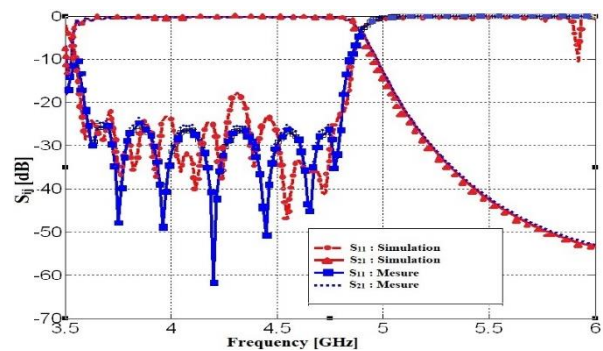

Figure 8. Comparison of theoretical reflection coefficients and those obtained by measurements, band C (WR229)

As we can observe in both cases, we obtained a good agreement between the theoretical and experimental results. We notice that the results obtained using the two tools simulation is in agreement with those resulting from the experimental results. We note a good consistency between the results. This also demonstrates the ability of Mician and CST to design this type of filter. The bandwidth of first filter is on the order of 0.7 GHz and its center frequency is close to 9.85 GHz. We notice a good matching of the transition characterized by a return losses around (23 dB), and insertion losses around (0.05 dB) in the useful band. The bandwidth of second filter is on the order of 1 GHz and its center frequency is close to 4.10 GHz. We notice a good matching of the transition characterized by a return losses around (25 dB), and insertion losses around (0.05 dB) in the useful band. The designed filters has the best measurement performance reported in the literature to date [26]-[29]. The results obtained are promising and pave the way for the use of these structures in the fields of telecommunications.

4. CONCLUSION

In summary, we have presented two symmetrical filters based respectively on standard rectangular waveguides WR90 and WR229 in which resonant irises are inserted, operating respectively in the X-Band (9–11.5) GHz and C-Band (3.5–5.5) GHz. The simulated results are in good agreement with those obtained by the experimental once. The bandwidth of first filter is on the order of 0.7 GHz and its center frequency is close to 9.85 GHz. We notice a good matching of the transition characterized by a reflection coefficient around (-23 dB) in the useful band. The bandwidth of second filter is on the order of 0.7 GHz and its center frequency is close to 4.1 GHz. We notice a good matching of the transition characterized by a reflection coefficient around (-25 dB) in the useful band.



REFERENCES

- [1] G. L. Matthaei, L. Young, and E. M. T. Jones, *Microwave filters, impedance-matching networks, and coupling structures*, New York, USA: McGraw-Hill, 1964. [Online]. Available: <https://ia803103.us.archive.org/15/items/MicrowaveFiltersImpedanceMatchingNetworksAndCouplingStructures/Microwave%20Filters%2C%20Impedance-Matching%20Networks%2C%20and%20Coupling%20Structures.pdf>
- [2] P. A. Rizzi, *Microwave engineering passive circuits*, USA: Prentice-Hall, Inc, 1988. [Online]. Available: <https://www.scribd.com/document/367501826/Microwave-Engineering-Peter-A-Rizzi-pdf>
- [3] A. Mediavilla, A. Tazon, J. A. Pereda, M. Lazaro, I. Santamaria, and C. Pantaleon, "Neuronal Architecture for Waveguide Inductive Iris Bandpass Filter Optimization," in *Proc. of the IEEE-INNS-ENNS International Joint Conference on Neural Networks. IJCNN 2000. Neural Computing: New Challenges and Perspectives for the New Millennium*, 2000, pp. 395-399, vol. 4, doi: 10.1109/IJCNN.2000.860804.
- [4] H. B. M. Hairi, Saktioto, R. F. Syahputra, Okfalisa, and S. Anita, "Transmission spectra of single ring coupled-waveguide resonator configuration by finite difference time domain method," *TELKOMNIKA (Telecommunication Computing Electronics and Control)*, vol. 18, no. 5, pp. 2251–2256, 2020, doi: 10.12928/telkomnika.v18i5.12621.
- [5] M. Bendaoued, R. Mandry, L. El Abdellaoui, A. Fouad, M. Latrach, and A. Lakhssassi, "Coplanar waveguide low pass filter based on square complementary split ring resonator with wide rejection," *TELKOMNIKA (Telecommunication Computing Electronics and Control)*, vol 18, no 5, pp. 2314-2319, 2020, doi: 10.12928/telkomnika.v18i5.15862.
- [6] D. L. -Boyenga, C. N. Mabika, and A. Diezaba, "A New Multimodal Variational Formulation Analysis of Cylindrical Waveguide Uniaxial Discontinuities," *Research Journal of Applied Sciences, Engineering and Technology*, vol. 6, no. 5, pp. 787-792, 2013, doi: 10.19026/rjaset.6.4120.
- [7] I. Badaoui, N. A. Touhami, S. Finish, and M. Lamsalli, "Substrate integrated waveguide band-pass filter for X band applications," *International Journal of Microwave and Optical Technology*, vol. 13, no. 4, pp. 337–342, 2018. [Online]. Available: https://www.researchgate.net/publication/326413422_Substrate_integrated_waveguide_band-pass_filter_for_X_band_applications
- [8] L. Li, Z. Wu, K. Yang, X. Lai, and Z. Lei, "A Novel Miniature Single-Layer Eighth-Mode SIW Filter with Improved Out-of-Band Rejection," *IEEE Microwave and Wireless Components Letters*, vol. 28, no. 5, pp. 407–409, 2018, doi: 10.1109/LMWC.2018.2813883.
- [9] J. Uher, J. Bohrmann, and U. Rosenberg, *Waveguide components for antenna feed systems: Theory and CAD*, Universitas Michigan: Artech House, 1993. [Online]. Available: https://books.google.co.id/books/about/Waveguide_Components_for_Antenna_Feed_Sy.html?id=0P5SAAAAMAAJ&redir_esc=y
- [10] J. Bomemann, and F. Arndt, "Modal S-Matrix Design of Metal Finned Waveguide Components and its Application to Transformers and Filters," *IEEE Transactions on Microwave Theory and Techniques*, vol. 40, no. 7, pp. 1528–1537, 1992, doi: 10.1109/22.146334.
- [11] P. Bhartia and P. Pramanick, *Modern RF and Microwave Filter Design*, Artech, 2016. [Online]. Available: <https://ieeexplore.ieee.org/document/9100974>
- [12] L. Gong, K. Y. Chan, and R. Ramer, "A four-state iris waveguide bandpass filter with switchable irises," in *2017 IEEE MTT-S International Microwave Symposium (IMS)*, 2017, pp. 260-263, doi: 10.1109/MWSYM.2017.8059090.
- [13] X. Wen, J. Xu, B. Wang, and L. Xue, "Design Waveguide Filters and Multiplexers by Fullwave Equivalent Circuit Approach," in *2005 Asia-Pacific Microwave Conference Proceedings*, 2005, doi: 10.1109/APMC.2005.1606295.
- [14] E. Mohammadi and H. Ghorbaninejad, "Novel resonant structure to compact partial H-plane band-pass waveguide filter," *International Journal of Electrical and Computer Engineering*, vol. 7, no. 1, pp. 266–270, 2017, doi: 10.11591/ijece.v7i1.pp266-270.
- [15] H. Setti, A. Tribak, A. El Hamichi, J. Zbitou, and A. Mediavilla, "K-Band Waveguide T-junction Diplexer For Satellite Communication," *TELKOMNIKA (Telecommunication Computing Electronics and Control)*, vol. 17, no. 2, pp. 549-554, doi: 10.12928/telkomnika.v17i2.9205.
- [16] S. Hardiati, Sulistyarningsih, and T. T. Estu, "The design of waveguide band pass filter with double-irises structure for airport surveillance radar applications on S-band frequency," *AIP Conference Proceedings*, 2016, vol. 1755, no. 1, doi: 10.1063/1.4958612.
- [17] L. Yechou, A. Tribak, M. Kacim, A. Serroukh, and J. Terhzaz, "Waveguide High-pass filter Design and 2D-FDTD Analysis method," *Mediterranean Telecommunications Journal*, vol. 9, no. 1, 2019. [Online]. Available:



- <https://revues.imist.ma/index.php/RMT/article/view/14054/8632>
- [18] R. E. Collin, "Foundations for Microwave Engineering." New York, USA: McGraw Hill, 1992. [Online]. Available: https://radfiz.org.ua/share/sheva_s8_DEK/SECONDARY/%E4%C5%D2%D6/%E4%C5%D2%D6/%CE%D7%DE%20%D4%C5%C8%CE%A6%CB%C1/%CC%A6%D4/Collin.%20Foundations%20for%20Microwave%20Engineering.pdf
- [19] R. C. Booton, *Computational methods for electromagnetics and microwaves*, John Wiley and & sons, Inc, 1992. [Online]. Available: <https://www.wiley.com/en-us/Computational+Methods+for+Electromagnetics+and+Microwaves-p-9780471528043>
- [20] M. M. Darwish, A. M. El-Tager, H. N. Ahmed, and H. S. El-Hennawy, "Design of In-Line Dual-Mode Rectangular Waveguide Bandpass Filters Using Multiple Inductive Circular Posts," *2008 38th European Microwave Conference*, 2008, pp. 500-503, doi: 10.1109/EUMC.2008.4751498.
- [21] W. John and F. Nunes, "4 Transmission Lines, Waveguides, and Equivalent Circuits," *Light-Matter Interaction: Physics and Engineering at the Nanoscale*, Oxford, 2012, doi: 10.1093/acprof:oso/9780198567653.003.0007.
- [22] M. Aqib, R. Mehmood, A. Alzahrani, I. Katib, A. Albesri, and S. M. Altowajiri, "Smarter traffic prediction using big data, in-memory computing, deep learning and GPUs, vol. 19, no. 9, 2019, doi: 10.3390/s19092206.
- [23] L. Christie and P. Mondal, "Mode Matching Method for the Analysis of Cascaded Discontinuities in a Rectangular Waveguide," *Procedia Computer Science*, vol. 93, pp. 251-258, 2016, doi: 10.1016/j.procs.2016.07.208.
- [24] R. J. Cameron, C. M. Kudsia, and R. R. Mansour, *Microwave filters for communication systems: fundamentals, design, and applications*, John Wiley & Sons, Inc., 2018, doi: 10.1002/9781119292371.
- [25] D. M. Pozar, *Microwave Engineering*, USA: Wiley, 2011. [Online]. Available: [http://mwl.diet.uniroma1.it/people/pisa/SISTEMI_RF/MATERIALE%20INTEGRATIVO/LIBRI/Pozar_Microwave%20Engineering\(2012\).pdf](http://mwl.diet.uniroma1.it/people/pisa/SISTEMI_RF/MATERIALE%20INTEGRATIVO/LIBRI/Pozar_Microwave%20Engineering(2012).pdf)
- [26] J. L. Cano, A. Mediavilla, and A. Tazon, "On the use of a new class of simplified multi-window iris notch in the design of ultra-compact high-rejection waveguide filters for satellite links," *Electronics*, vol. 9, no. 8, 2020, doi: 10.3390/electronics9081221.
- [27] C. Guo, J. Powell, X. Shang, M. J. Lancaster, J. Xu, and C. Viegas, "A W-Band Frequency Tripler with Integrated Waveguide Filter Matching," in *2018 48th European Microwave Conference (EuMC)*, 2018, pp. 1317-1320, doi: 10.23919/EuMC.2018.8541657.
- [28] Z. Liu, J. -Y Deng, and D. Sun, "Slow-Wave Groove Gap Waveguide Bandpass Filter," *IEEE Access*, vol 7, pp. 52581–52588, 2019, doi: 10.1109/ACCESS.2019.2912496.
- [29] M. Rezaee, A. U. Zaman, and P. -S. Kildal, "A groove gap waveguide iris filter for V-band application," *2015 23rd Iranian Conference on Electrical Engineering*, 2015, pp. 462-465, doi: 10.1109/IranianCEE.2015.7146259.

BIOGRAPHIES OF AUTHORS



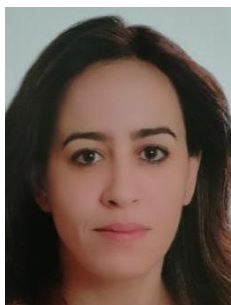

Hicham Setti    was born in Larache, Morocco, in 1980. He received the master's degree in electronics and Telecommunication and the M.Sc. degree in physics respectively in 2008 and 2019 from Abdelmalek Essaadi University, Tétouan, Morocco. Since 2010, he has been a Professor of physics with the Ministry of National Education, Tanger, Morocco. His current research interests include microwave circuits and systems and antenna feed subsystems for satellite and radio astronomy applications. Based on document published on 2 May 2018. He can be contacted at email: hsetti1981@gmail.com.



Asmae Mimouni    is an Assistant professor of physics in Al-Imam Mohammad Ibn Saud Islamic University, Riyadh, Saudi Arabia. She obtained PhD degree in Electronics, Abdelmalek Essaadi University, Tetouan, Morocco, 2013, and received her international PhD in information technology and communications in telecommunication systems, Cantabria University Spain, 2012. Her research interests are focusing on Telecommunication system, Antenna, RF application, Miniaturization of Antenna and her development. She can be contacted at email: amalmimouni@imamu.edu.sa.



Abdelwahed Tribak    was born in Larache, Morocco, in 1981. He received the M.Sc. degree in physics from Abdelmalek Essaadi University, Tétouan, Morocco, in 2006, and the master's degree in communications engineering and Ph.D. degree in telecommunications from the University of Cantabria, Santander, Spain, in 2008 and 2011, respectively from 2006 to 2011, he was with the Department of Communications Engineering, University of Cantabria. Since 2011, he has been a Professor with the National Institute of Poste and Telecommunication, Rabat, Morocco. His current research interests include microwave circuits and systems and antenna feed subsystems for satellite and radio astronomy applications. Based on document published on 2 May 2018. He can be contacted at email: tribak_ma@yahoo.fr.