

Electrical Tracking Formation on Silane Epoxy Resin under Various Contaminants

Abdul Syakur^{*1}, Hamzah Berahim², Tumiran³, Rochmadi⁴

^{*1,2,3} Department of Electrical Engineering and Information Technology,
Gadjah Mada University, Jl. Grafika 2, Yogyakarta, Indonesia, 55281

¹ Department of Electrical Engineering, Diponegoro University
Jl. Prof. Soedarto SH, Semarang, Indonesia, 50275

⁴ Department of Chemical Engineering, Gadjah Mada University
Jl. Grafika 2, Yogyakarta, Indonesia, 55281

e-mail: syakur@undip.ac.id¹, hberahim@mti.ugm.ac.id², tumiran@te.ugm.ac.id³

Abstrak

Kontaminasi pada permukaan isolator menjadi masalah serius. Khususnya untuk daerah tropis. Kelembaban dan hujan memainkan peranan yang penting dalam mengisi kebasahan permukaan isolator yang menghasilkan kontaminan dan arus bocor mengalir pada permukaan isolator. Arus bocor ini akan membangkitkan panas yang terjadi pada permukaan isolator. Hal ini akan mengawali terjadinya lewat denyar. Makalah ini mempresentasikan pengaruh kontaminan terhadap arus bocor dan pembentukan jejak listrik pada permukaan sampel resin epoksi dicampur silicon rubber. Uji dilakukan berdasarkan metode Inclined Planed Tracking dengan kontaminan NH_4Cl . Penggunaan kontaminan industri dan pantai untuk menjelaskan pengaruh kontaminan terhadap proses penjeakan permukaan. Laju aliran kontaminan 0.3 ml/menit. Tegangan 3.5 kV 50 Hz diterapkan ke elektroda atas. Ditemukan bahwa kontaminan industri menghasilkan arus bocor permukaan paling kecil 327.6 mA. Ditemukan kontaminan pantai menunjukkan kerusakan paling parah pada permukaan sampel. Oleh karena diperlukan perlakuan khusus pada sampel yang akan digunakan pada kondisi kontaminan tersebut agar unjuk kerja bahan dapat diperbaiki khususnya terhadap penjeakan listrik.

Kata kunci: kontaminan, resin epoksi, arus bocor, penjeakan listrik

Abstract

Contamination at the surface of the insulator becomes a serious problem. Especially for the tropical area, humidity and rainfall play an important role in wetness by the water at the insulator surface, which result in the presence of contaminant and leakage current flowing at the surface. This leakage current will generate heat which occurs at the surface of an insulator. This ultimately leads to flashover. This paper presents the influence of contaminants to leakage current and formation of electrical tracking at the surface of epoxy resin compound with silicon rubber. The test was based on IPT method with NH_4Cl as contaminants. The industrial and coastal contaminants are used to explain the effect of contaminant at surface tracking process. The flow rate of contaminant was 0.3 ml/min. The 3.5 kV AC high voltage 50 Hz was applied to the top electrodes. It is found that industrial contamination resulting in the smallest surface leakage current is 327.6 mA. Also it is found that coastal contaminant showed the severest damage at surface of test sample. Therefore, special treatment of the sample is needed under these conditions so that the material performance can be improved, especially against the electrical tracking.

Keywords: contaminant, epoxy resin, leakage current, electrical tracking

1. Introduction

Currently, polymer materials were developed and began to be used as an insulator on the electrical power transmission line, because it has better dielectric properties compared with porcelain and glass [1]. The usage of porcelain and glass insulator on high voltage system is inappropriate due to high specific mass (2.3-3.9 gram/cm³) which caused higher transmission tower cost. Another consideration is excessive energy used during porcelain and glass insulator manufacturing (over 1000°C for vulcanization). Polymeric insulator is more economic due to lower specific mass (0.9–2.5 gram/cm³), lower energy used during manufacturing (low temperature process: 25-80°C, high temperature process: 100-300°C, lower dielectric constant 2.3-5.5 (compare to porcelain dielectric constant: 5.0-7.5, glass: 7.3) and lower dissipation

factor $(0,1-5,0)(10^{-3})$ compared to porcelain $(20-40)(10^{-3})$ or glass $(15-50)(10^{-3})$ [2]. Based on some performance analysis of insulator that has been done, it was found that severest damage to the structure of insulators is the result of electrical tracking process at the surface of insulators. Electrical tracking process is a typical phenomenon which occurs at the surface of the insulator as a result of spots discharge arising at the surface induced. All were the result of the surface wetting and the level of contamination. Once tracking is initiated, the discharge is further accelerated and the track grows. Also once the tracking happens; the nature of the insulator surface will be reduced and cannot be recovered anymore. To enhance the capabilities and performances of insulator, the phenomenon of electrical tracking is investigated by researchers [3-5,18-19]. Leakage current characteristics on epoxy resin with various compound of silicon rubber on new sample and under tropical climate have studied [6-8,18-19].

Epoxy resin is one of polymeric materials used for high voltage insulators. It showed a considerable good tracking and erosion resistance and suitable for outdoor use. Epoxy resins were used in a large number of fields including surface coatings, adhesives, in potting and encapsulation of electronic components, in tooling, for laminates in flooring and to a small extent in molding powders and in road surfacing.

Compared with the polyesters, epoxy resins generally have better mechanical properties and, using appropriate hardeners, better heat resistance and chemical resistance, in particular, resistance to alkali. The electrical properties of epoxy resins have a dielectric constant about 3.4 – 5.7, and a dielectric strength about 100 – 220 kV/cm. Power factor of resin epoxy resins is about 0.008 – 0.04 [9]. There is several reports explained good insulation properties of epoxy resin used in polluted conditions [10-13]. According to Berahim [12] epoxy resin is a hydrophilic material therefore, in particular, in the tropical area; humidity and rainfall play an important role in accelerating of degradation process at the surface of the insulator.

Contamination layer will be formed at the surface of the insulator and it will spread at the surface. Leakage current will increase, especially when the insulator surface is wet caused by fog, dew or light rain. Leakage current will initiate the process of heat conduction which occurs at the surface of an insulator and finally flashover or insulation breakdown will occur. According to Tumiran [8], by using degradation and chemical structure analysis of the RTV silane epoxy resins, it can be known that silane treatment of the filler can improve the electrical performance of RTV epoxy resins insulation material in some operating conditions.

When the insulator is wet, a resistive surface LC flows, which is generally many orders of magnitude higher than the capacitive current in the case of dry insulators [5,13]. This LC results in non-uniform heating of the contamination layer that eventually causes dry bands to be formed at the narrow sections where the surface LC density is highest. The voltage distribution along the surface of wet polluted insulators is very non-uniform when a dry band is formed in series with the conductive film. Since the resistance of the dry band is very high, the whole applied voltage across the insulator appears across the dry band. As a result, the breakdown occurs across the dry band when it reaches the air critical flashover voltage and generates small sparks between the separating moisture films. This process acts effectively as an extension to the electrodes. The heat resulting from the small sparks causes carbonization and volatilization of the insulation and leads to the formation of permanent "carbon track" at the surface. The process is cumulative and continuous, and insulation failure occurs when carbonized tracks bridge the distance between the electrodes [5,14]. This phenomenon, called surface tracking commonly occurs at the insulator surface under wet contaminated conditions.

The phenomenon of tracking severely limits the use of organic insulations in the outdoor environment. The rate of tracking depends upon the structure of the polymers and adding appropriate fillers to the polymer that inhibit carbonization can drastically slow it down.

The degradation process of the materials due to the electrical discharge stress is influenced by the characteristics of LC and surface tracking behavior.

This paper presents the influence of contaminants on leakage current and formation of electrical tracking on epoxy resin material compound with silicon rubber (SiR). The kinds of contaminant used were NH_4Cl , coastal and industrial contaminants. Performance parameters which are investigated in this research are leakage current in mA and conditions of surface degradation after test observed by digital microscope. The purpose of this research was to find contaminant which cause severe damage at surface tracking at the sample.

2. Research Method

2.1. Research Material

A test material used in this research was epoxy resins formed from diglycidil ether of bisphenol-A (DGEBA) and metaphenylene-diamine (MPDA) compound with silicon rubber (SiR). Composition of test materials is 30% DGEBA, 30% MPDA and 40% Silicon Rubber [18]. To make the test sample, the first step is to mix the silicon rubber (40 grams) with DGEBA (30 grams), and then I stir until evenly distributed. The next step, I mixed MPDA (30 grams) to a mixture of the first one. As a side note, it is not recommended to mix DGEBA and MPDA in the first step because it will be difficult when mixed with silicon rubber. All the test samples made in the room temperature vulcanized (RTV)

The samples were prepared in the form of blocks with dimension of 50 mm x 120 mm x 6 mm. Test samples were drilled to place electrodes as illustrated in Figure 1 (a) and (b) :

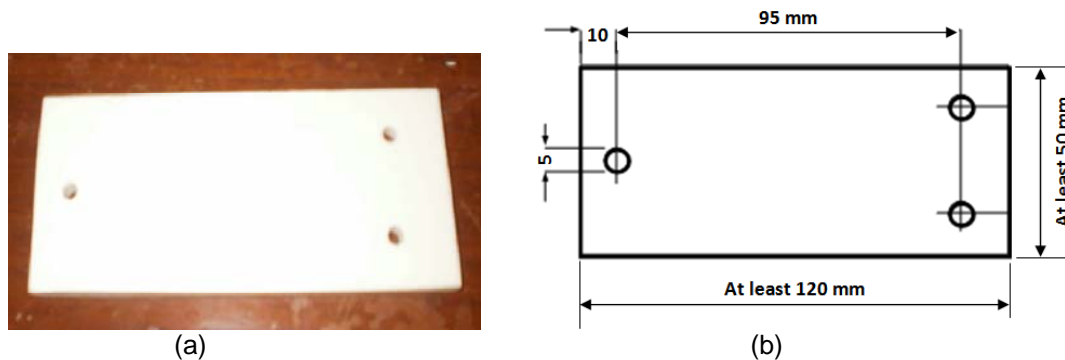

Figure 1. (a) Physical view of test sample and (b) Schema of test sample and its dimension

Epoxy is a thermosetting chemical compound which contains oxygen and carbon chemical bond produced by epichlorohydrin and bisphenol A reaction. Complex structure of Epoxy has molecular epoxy-resin bond shown in Figure 2.

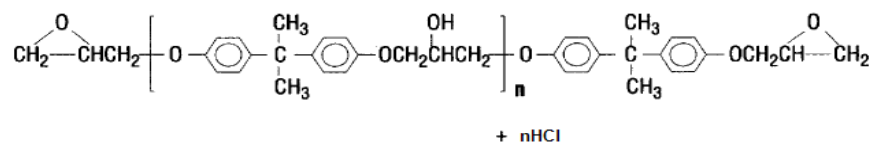

Figure 2. Epoxy-resin structure

Epoxy-resin will be hardened when combined with hardener, catalyst and filler. The application is widely used, such as: insulator, household tools, machinery component, automotive, liquid tank/pipe, aeroplane body material, aerospace component, bridge structure, etc. Epoxy has good electrical properties: volume resistance (ρ) $10^{13} - 10^{15} \Omega\text{m}$, dielectric constant (ϵ) 3.5 - 3.9 (at 50/60 Hz) and power dissipation factor ($\tan \delta$) $(35-90) \times 10^{-4}$, but is weak against ultraviolet radiation.

Silicon rubber is a PDMS which has CH_3 as side group. Different chemical compound in every bond will give different property for each polymeric material [15]. Silicon rubber chemical structure has more flexible siloxane backbone compared to other polymeric material. This flexibility advantage can be understood by chain structure shown in Figure 3.

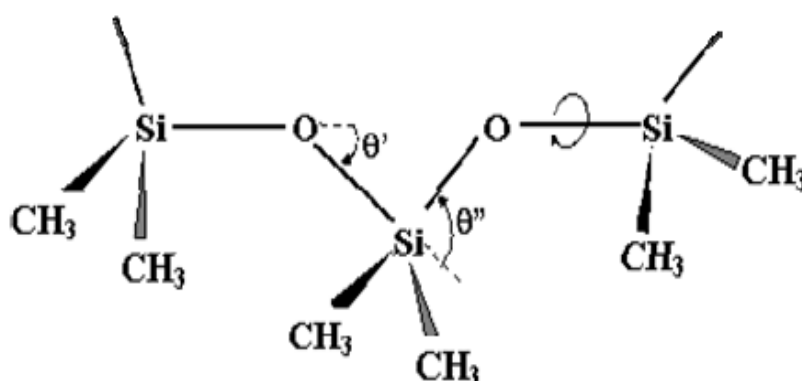

Figure 3. Silicon rubber chain structure

Silicon rubber chain structure doesn't have carbon at the backbone, but present at side group. Those structure show semi-organic structure with high bond energy of S-O which gives very high thermal stability. Bond energy of Si-O is 25% higher than C-C in ethylene backbone. The comparison of main bond energy of several polymeric compound is shown in Table 1.

Table 1. Polymeric material bond energy

Atomic Bond	Bond Energy (kJ/mol)
C-H	413
C-O	360
C-N	308
C-C	348
H-H	436
H-O	366
H-N	391
Si-O	445
Si-H	318
Si-C	318
Si-Si	222
O-O	195
O-H	366

Eventhough Si-O thermal stability is very good, the ionic property is relatively high which made it easier to be broken by high alkali or acid concentration. Strong Si-O bond gives higher durability for silicon rubber against destruction possibility caused by environment and corona. It also gives same similar property as glass or quartz which don't cause conductive layer when burned (for example : burned by electrical arc). In the other hand, silicon rubber also has stable elasticity within -50°C to $+230^{\circ}\text{C}$ range which is the most important property of electrical insulator material [16].

2.2. Electrodes

All electrodes, fixtures and assembly elements associated with the electrodes, such as screws, shall be made of stainless steel material [17]. The electrode assembly is shown in Figure 4 (all dimension in mm). The top electrode is shown in Figure 4.a and the bottom electrode is shown in Figure 4.b.



Figure 4. (a) Top, (b) Bottom of the electrodes

2.3. Contaminants

There are three kind of contaminants used in this research. The first contaminant had concentration of 0.1 ± 0.002 % by mass of NH_4Cl (ammonium chloride) and its conductivity is $2170 \mu\text{S/cm}$. Other contaminants are from industrial and coastal area. Conductivity of industrial contaminant is $3540 \mu\text{S/cm}$ and conductivity of coastal contaminant is $1420 \mu\text{S/cm}$. Detail of industrial and coastal contaminant data are as follow:

Table 2. Elements and content of industrial contaminants

Contaminant from Semen Gresik industrial			
Name	content	data (ppm)	weight (mg)
K+	KCl	3.4035	6.5016
Na+	NaCl	310.46	789.6483
Ca++	CaCl_2	239.94	665.8335
Mg++	$\text{MgCl}_2 \cdot 6\text{H}_2\text{O}$	76.786	649.4816
Conductivity		3540 $\mu\text{S/cm}$	

Table 3. Elements and content of coastal contaminants

Contaminant from Parangtritis beach			
Name	Content	Data (ppm)	Weight (mg)
K+	KCl	1.1	2.0872
Na+	NaCl	183.3	466.2196
Ca++	CaCl_2	35.135	97.4996
Mg++	$\text{MgCl}_2 \cdot 6\text{H}_2\text{O}$	28.807	243.6592
Conductivity		1420 $\mu\text{S/cm}$	

From Table 2 and 3, we know contaminant from industrial and coastal areas have some elements such as Kalium (K), Natrium (Na), Calcium (Ca) and Magnesium (Mg).

2.4. Filter Paper

These contaminants were flowed on the surface of materials using a peristaltic pump. There were eight layers of filter-papers as a reservoir for the contaminant that was clamped between the top electrode and the specimen. The approximate dimensions were given in fig. 5.

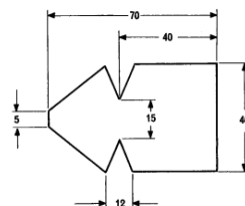

Figure 5. Filter paper and it dimensions

2.5. Test Circuit

The tests were carried out using a high voltage AC 50 Hz. The test voltage 3.5 kV was applied to the top electrode while a contaminant flowed along the underside of the sample. In this test, method 1 : the constant tracking voltage was used, and the time to start tracking was also determined. The schematic diagram for this test is illustrated in Figure 6.

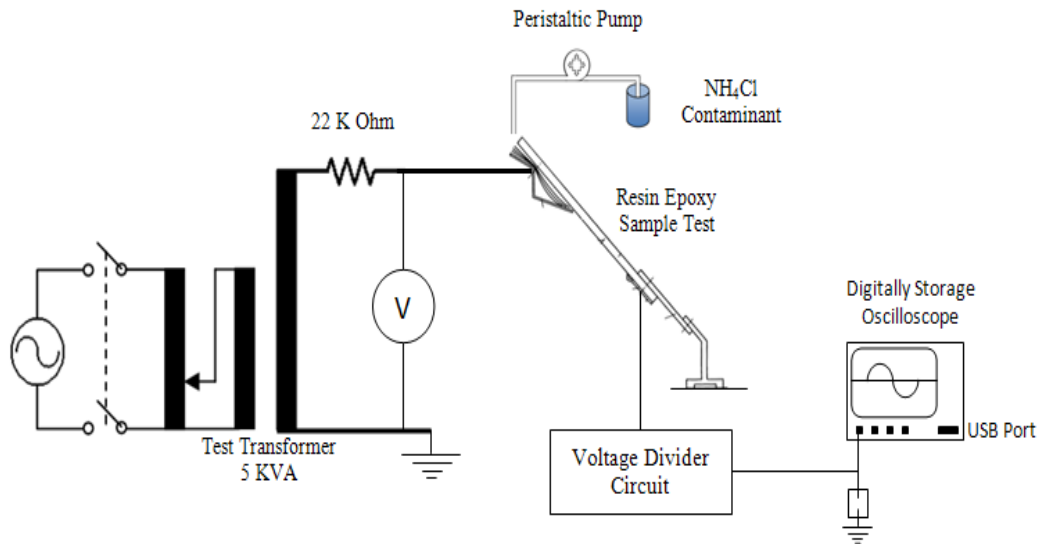

Figure 6. Schematic diagrams for this test.

High voltage AC 50 Hz with a voltage of 3.5 kV was generated from 5 kVA transformer test. Resistor 22 k Ω was used to resist the current flowing on the surface of the material in the event of discharge. Peristaltic pump was used to drain the solution of contaminants.

Table 4. Test voltage, contaminant flow rate and series resistor

Test voltage (kV)	Preferred test voltage for method 1 (kV)	Contaminant flow rate (ml/min)	Series resistor, resistance (k Ω)
1.0 ~ 1.75	-	0.075	1
2.0 ~ 2.75	2.5	0.15	10
3.0 ~ 3.75	3.5	0.30	22
4.0 ~ 4.75	4.5	0.60	33
5.0 ~ 6.00	-	0.90	33

Discharge current will be read and recorded by Oscilloscope in time of discharge at the surface of the material. Measurement data in the form of discharge current and discharge time of the first occurrence was then stored and used to analyze the surface condition. Figure 7 below describe the flow of contaminant from top electrode (Fig.7.a) while the formation electrical track from the bottom electrode (Fig.7.b).

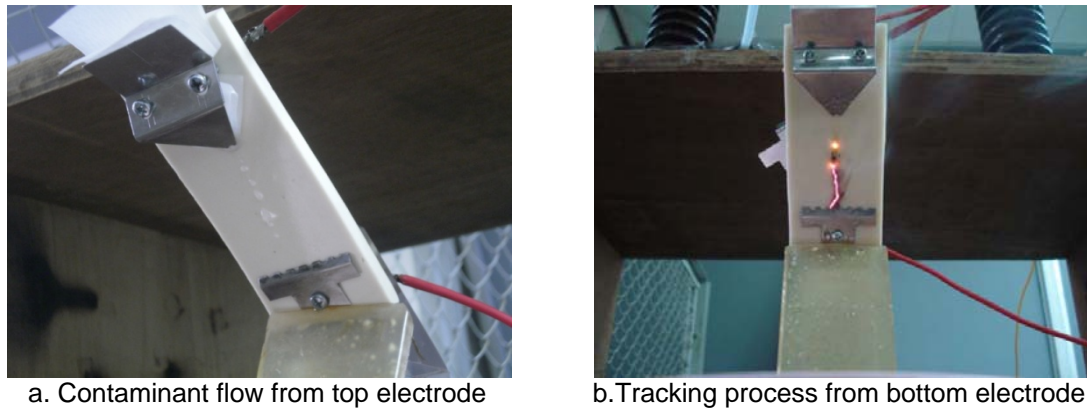

Figure 7. The electrical tracking processes at the surface of insulation

3. Results and Analysis

3.1. Leakage Current

Leakage current characteristics and surface conditions of sample at several of the contaminant degree were expressed by conductivity value. All conductivity data results are shown in the Table 5 as follow:

Contaminants	Conductivity ($\mu\text{S}/\text{cm}$)	Discharge Current (mA)	Discharge time (sec.)
Coastal	1420	3084,9	4746
NH_4Cl	2170	535,0	550
Industrial	3540	-327,6	818

Based on Figure 8 we know the discharge started to occur at 4746 second for coastal contaminant (1420 $\mu\text{S}/\text{cm}$) and at 550 second for NH_4Cl (2170 $\mu\text{S}/\text{cm}$) in Figure 9 and at 818 second for industrial contaminant (3540 $\mu\text{S}/\text{cm}$) in Figure 10.

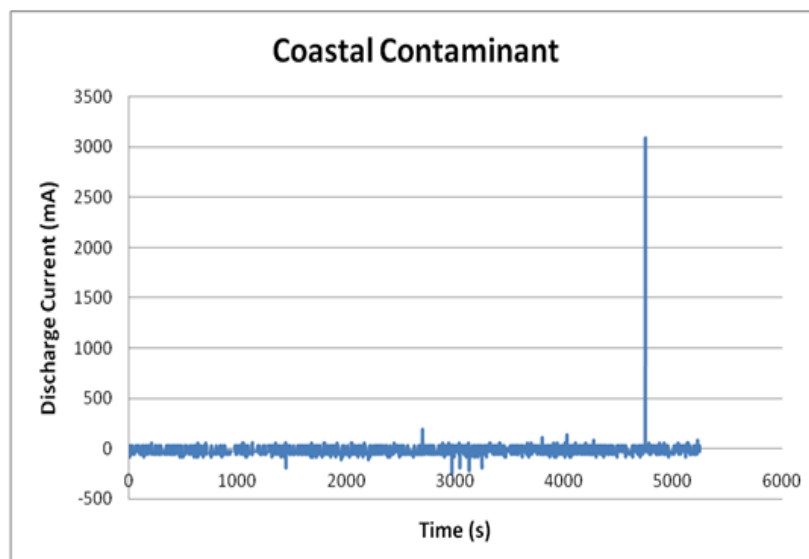

Figure 8. Leakage current with coastal contaminant

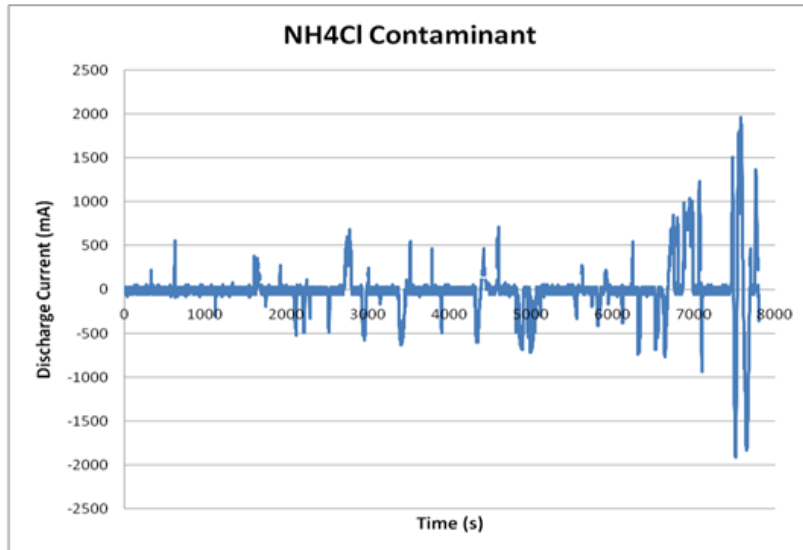

Figure 9. Leakage current with NH_4Cl contaminant

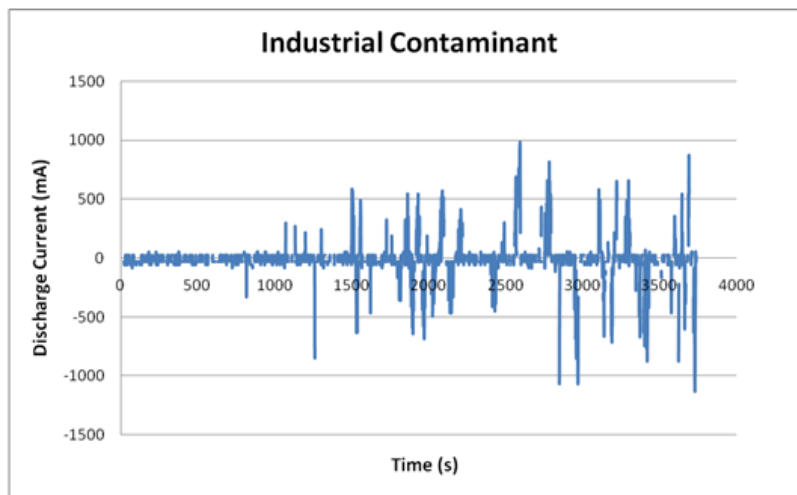

Figure 10. Leakage current with industrial contaminant

Figures 8, 9 and 10 show the influence of contaminant on leakage current of test samples. Also, we know that the first discharge time and current discharge are influenced by the conductivity of the contaminant. The conductivity of contaminant plays an important role in increasing the surface tracking at the surface of polymer materials. At a very high conductivity ($3540 \mu\text{S}/\text{cm}$ as industrial contaminant), the current discharge is smallest. Meanwhile for coastal contaminant with $1420 \mu\text{S}$, it needs longer time to discharge occurred but the current discharge was very high. Contaminant at the surface of the material with high conductivity tends to become conductive bridge between top and bottom electrode when the contaminant was flowed.

Comparing figures 8, 9 and 10, it is concluded that conductivity of contaminant plays an important role in initiate the leakage current.

3.2. Formation of Electrical Tracking

Electrical tracking at the surface of the material sample is due to heating at the surface of the material at the time of leakage current flow. Leakage current at the surface of the material

occurs due to the contaminants that flow on the surface material. Different contaminant shows various result of electrical tracking form.

When the flashover voltage of air critical (V_c) was achieved, carbonization process took place and water vaporization happened. Permanent carbonized path were formed. These process were continuous and cumulative and finally insulation breakdown occurred. Surface discharge also happened. Erosion at samples surface was followed by formation of pattern filament in which produce electrical tracking. Various surface condition for each contaminant is shown in Figure 11. Surface damage condition for each samples at different kind contaminant were investigated by digital microscope (zoom in 500 times). Conditions of sample surface are shown in Figures 12, 13 and 14, respectively:



Figure 11. Surface conditions after test

Figure 11 (a) shows the track on epoxy resin sample with coastal contaminant. The track is a partially-conducting path created by localized deterioration on the surface of an insulating material. Formation of The track begins from top electrode. But, Figure 11(b) and (c) show the track start from bottom electrode. X. Wang [3] investigated the tracking induced on polystyrene sample using acid rain and NH_4Cl . The track on virgin sample is narrow and shallow, like a bean sprout, but that on aged samples spreads all over, like the jungle. It is clear that the discharge and tracking on an aged sample are severer than those on a virgin sample, and tracking is easily induced on the aged sample. When a virgin sample is subjected to the tracking test using acid rain contaminant instead of the NH_4Cl solution, the track propagates and penetrates deeply into the sample like Figure 12 and 14, the reason being that the artificial acid rain used is severer than the NH_4Cl solution, i.e. has higher acidity and conductivity.

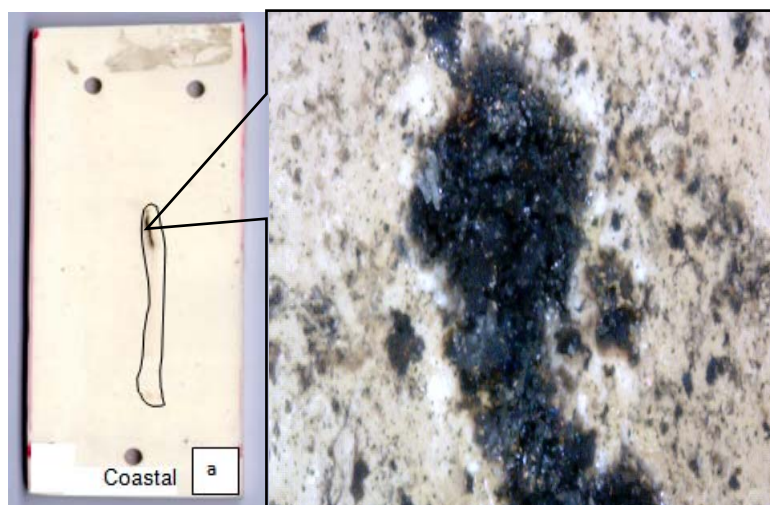

Figure 12. Surface condition with coastal contaminant

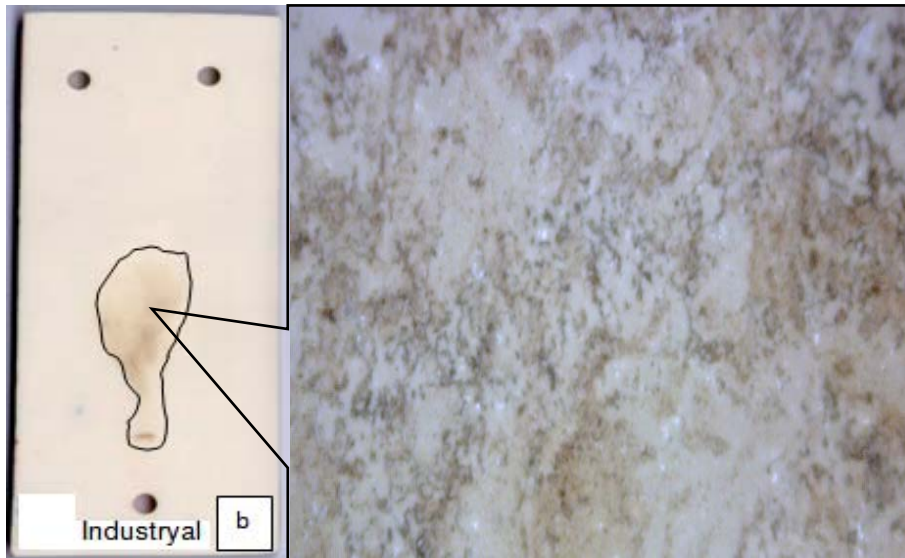

Figure 13. Surface condition with industrial contaminant

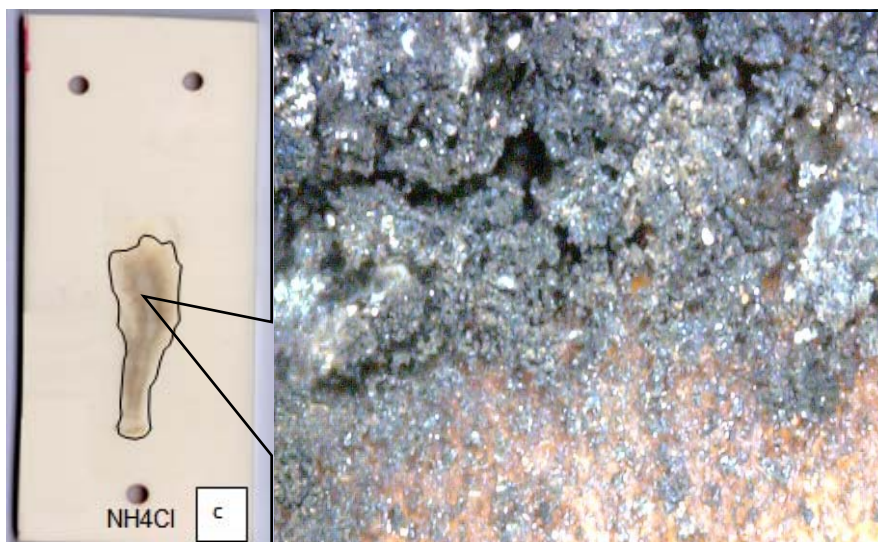

Figure 14. Surface condition with NH_4Cl contaminant

From the figures 12, 13 and 14, we know that severest damage of sample surface was with coastal contaminant (Fig.12). The forming of carbon happen at the sample surface. This also happen at the sample with NH_4Cl contaminant (Fig. 14), however, samples with industrial contaminants had wider surface damage than that of the coastal contaminant (like bush).

Sarathi [5] explained that tracking is a surface-degradation phenomenon that occurs when the contaminants collect on the surface of an insulation material. When AC high voltage is connected to the top electrode, leakage current flows in the conductive path formed by the contaminant (between top and bottom electrode). This leakage current causes non-uniform heating of the surface, thereby forming a dry-band zone in the continuous wet film formed by the contaminant flow, resulting in regions of very high resistivity between the edges of the remaining wet film surface. Electrical tracking on the surface of the material sample is due to heating at the

surface of the material at the time of leakage current to flow and once the process of erosion. Leakage current on the surface of the material is due to the contaminants that flow on the surface material. Nearly the entire surface voltage (the applied voltage) will appear across the dry band.

4. Conclusion

The electrical tracking of epoxy resin compounded with the silicon rubber at various contaminant were investigated by analyzing leakage current and formation of electrical tracking under the inclined-plane tracking test method. The experimental results showed that the contaminants significantly affect the electrical tracking process. Influence of these contaminants can be analyzed using discharge current parameters, i.e. the timing of discharge and material surface conditions.

Based upon experiment result, it is found that industrial contamination resulting in the smallest surface leakage current is 327.6 mA. Also it is found that coastal contaminant (1420 $\mu\text{S}/\text{cm}$) showed the severest damage at surface of test sample. Therefore special treatment are needed to test sample under conditions of coastal and NH_4Cl contaminants, so that the material performance can be improved, especially against the electrical tracking.

References

- [1] Gorur RS, EA Cherney, JT Burnharn. Outdoor Insulators. Ravi S. Gorur, Inc., Phoenix, Arizona 85044 USA, 1999.
- [2] Looms, J.S.T. Insulator for High Voltage. London: Peter Preginus Ltd. 1988.
- [3] X. Wang, L.Chen and N. Yoshimura. Erosion by Acid Rain, Accelerating the Tracking of Polystyrene Insulating Material. *Journal Phys.D: Appl. Phys.* 2000; (33): 1117-1127.
- [4] Piah, M.A.M, Darus A, Hassan A. Electrical Tracking Performance of LLDPE-Natural Rubber Blends by Employing Combination of Leakage Current Level and Rate of Carbon Track Propagation, *IEEE Transactions on Dielectrics and Electrical Insulation.* 2005; 12(6): 1259-1265.
- [5] Sarathi, R., Chandrasekar, S., Sabari Giri V, Venkateshaiah C, Velmurugan R. Analysis of Surface Degradation of High Density Polyethylene (HDPE) Insulation Material Due to Tracking, *Bulletin Material Science.* 2004; 27(3): 251-262.
- [6] Syakur, A., Hamzah Berahim, Tumiran, Rochmadi. *Leakage Current Measurement of epoxy resin compound with Silicon Rubber.* Proceedings of International Conference on Electrical Engineering and Informatics. Bandung. 2011:1130.
- [7] Syakur, A., Hermawan, Sarjiya, Hamzah Berahim, Analyze of Hydrophobic Characteristics of Surface Material Based on The Value of THD Leakage Current. *TELKOMNIKA Indonesian Journal of Electrical Engineering.* 2009; 7(2): 109-118.
- [8] Tumiran, Arif Jaya, Berahim, H., Rochmadi, Accelerated Aging Effect on Epoxy-polysiloxane Polymeric Insulator Material with Rice Husk Ash Filler. *TELKOMNIKA Indonesian Journal of Electrical Engineering.* 2012; 10(4): 655-666.
- [9] J.A. Brydson, Plastic Materials. 4th edition, Butterworth Scientific, 1982: 693-695.
- [10] Kumagai,S., Yoshimura,N., Impacts of Thermal Aging and Water Absorption on Surface Electrical and Chemical Properties of Epoxy Resin. *IEEE Transaction on Dielectric and Electrical Insulation.* 2000; 7(3): 424-431.
- [11] Gorur, R.S., Montesinos, J., Electrical Performance of Cycloaliphatic Epoxy Materials and Insulators for Outdoor Use. *IEEE Transaction on Power Delivery.* 2000; 15(4): 1274-1278.
- [12] Berahim, H. Methodology to Assess The Performance of Silane Epoxy Resin Insulating Polymer as High Voltage Insulator Materials in The Tropical Areas. PhD Thesis. Yogyakarta: Postgraduate UGM; 2005.
- [13] Fernando, M.A.R.M., Gubanski, S.M. Leakage Current on Contaminated Polymeric Surfaces. *IEEE Transaction on Dielectrics and Electrical Insulation.* 1999; 6(5): 688-694.
- [14] Naidu M.S., Kamaraju, V. High Voltage Engineering, 2nd Edition. New Delhi: Tata MC Graw Hill Publishing Company Limited. 1995.
- [15] Davis A., Sims D. Weathering of Polymers. First Edition. London: Applied Science Publisher Ltd. 1983.
- [16] Kind D, Kaerner H.C. High Voltage Insulation Technology. Braunschweig/Wiesbaden: Friedr Vieweg & Sohn.1985.
- [17] IEC Publication 1984. *Testing Method for Evaluating Resistance of Tracking and Erosion of Electrical Insulating Materials Used Under severe Ambient Conditions.* British Standards Institution. No. 587.

- [18] Syakur, A., Hamzah Berahim, Tumiran, Rochmadi. Experimental Investigation on Electrical Tracking of Epoxy Resin Compound with Silicon Rubber. *Journal of High Voltage Engineering*. 2011; 37(11); 10886 – 10891.
- [19] A. Krivda, LE Schmidt, X. Kommann, H. Ghorbani, A. Ghorbandaeipour, M. Eriksson, H. Hillborg, Inclined-plane Tracking and Eroison Test According to the IEC 60587 Standard. *IEEE Electrical Insulation Magazine*, 2009; 25(6); Nov- Dec; pp. 14-29.